

CYO Single-lever basin mixer with pop-up waste - Brushed Platinum

33 500 811







- 143mm projection
- fixed spout
- rectangular, air-enriched flow
- height of mixer 180 mm
- height up to aerator 128 mm
- hole diameter 35 mm
- 2x screw-in M 8 x 1 pressure hose, leak-tested
- max. flow 4.5 l/min
- lead-free
- This product can help a building meet the requirements of Green Building Rating Systems, e.g. LEED®, BREEAM®, DGNB
- WRAS

Only suitable for basins with an overflow.

Must not be combined with continuous-flow heaters heaters.

Distance from centre of tap hole to wall min. 55 mm or to front edge of basin min. 40 mm.

	Brushed Platinum	33 500 811-06
	Chrome	33 500 811-00
	Dark Chrome	33 500 811-19
	Brushed Durabronze (23kt Gold)	33 500 811-28
	Brushed Dark Platinum	33 500 811-99

CYO Single-lever basin mixer with pop-up waste - Brushed Platinum

33 500 811

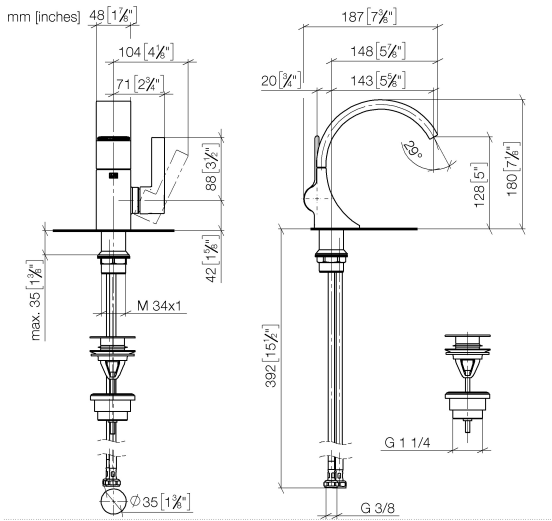

Flow rate chart

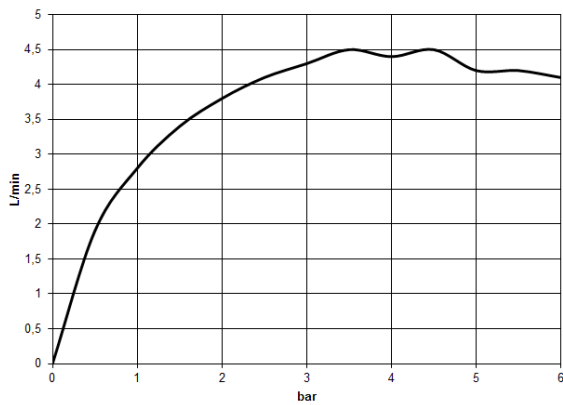

Codes & Standards

DIN 4109

Executive Order
no. 1007

ISO 3822

Scottish Water
Byelaws

UK Water Supply
Regulations

Ü-Zeichen



CYO Single-lever basin mixer with pop-up waste - Brushed Platinum

33 500 811

Certificates

GDV_0400

LGA_38

WRAS_2111

CYO Single-lever basin mixer with pop-up waste - Brushed Platinum

33 500 811

Parts for other finishes can be found here: [Chrome](#)

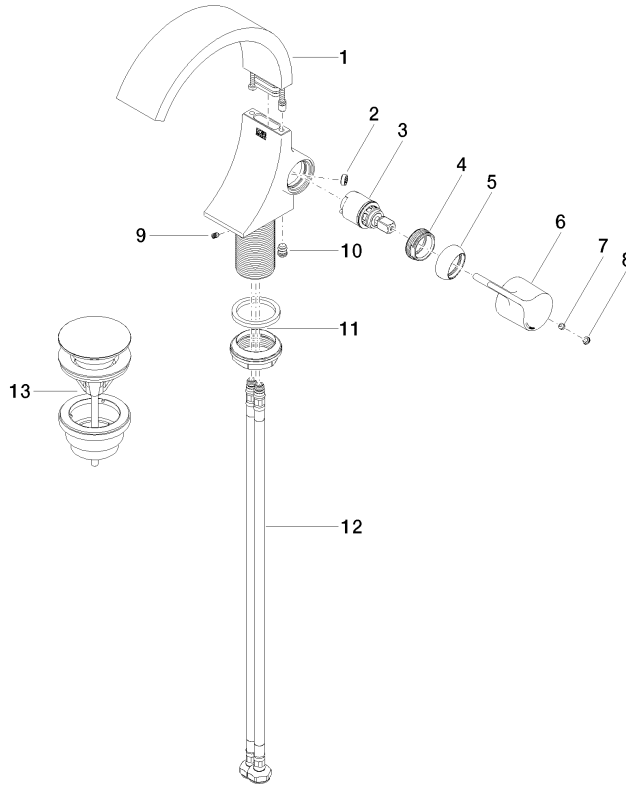

Spare parts list

No.	Item Number	Name	Quantity used	Delivery time
1	90 11 70 012 01-06	spout	1	10
2	09 23 01 172 90	flow reducer	1	2
3	90 15 05 044 00 90	cartridge	1	2
4	09 24 04 266 90	nut	1	2
5	09 28 30 021-06	cover	1	10
6	09 20 80 024-06	handle	1	10
7	90 31 11 030 00 90	pin	1	2
8	90 31 20 087 00-06	plug	1	10
9	09 31 11 008 90	pin	1	2
10	90 31 20 129 00 90	plug	1	2
11	04 23 10 044 07 90	fixing set	1	2
12	04 30 04 100 00 90	hose	2	2
13	10 125 970-06	Basin Waste with push fastening 1 1/4" - Brushed Platinum	1	2