

33 500 882



- 137mm projection
- pivotable spout 360°
- circular, air-enriched flow
- height of mixer 295 mm
- height up to aerator 187 mm
- hole diameter 35 mm
- 2x screw-in M 8 x 1 pressure hose, leak-tested
- max. flow 5.7 l/min
- lead-free
- This product can help a building meet the requirements of Green Building Rating Systems, e.g. LEED®, BREEAM®, DGNB
- WRAS 2212025

Only suitable for basins with an overflow.

	Brushed Platinum	33 500 882-06
	Chrome	33 500 882-00
	Platinum	33 500 882-08
	Dark Chrome	33 500 882-19
	Brushed Durabronze (23kt Gold)	33 500 882-28
	Matte Black	33 500 882-33
	Brushed Bronze	33 500 882-42
	Brushed Champagne (22kt Gold)	33 500 882-46
	Champagne (22kt Gold)	33 500 882-47
	Brushed Chrome	33 500 882-93
	Brushed Dark Platinum	33 500 882-99

33 500 882

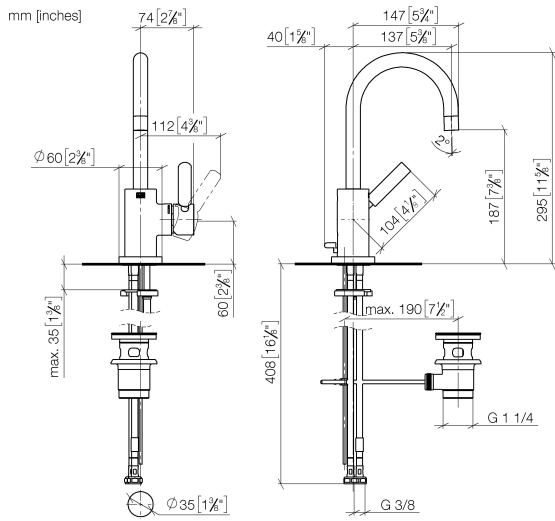

Flow rate chart



Codes & Standards

DIN 4109

ISO 3822

Scottish Water
Byelaws

UK Water Supply
Regulations

Ü-Zeichen



TARA Single-lever basin mixer with pop-up waste - Brushed Platinum

TARA

33 500 882

Certificates

LGA_38

WRAS_2212

33 500 882

Product version from 4/1/2024

Parts for other finishes can be found here: [Chrome](#)

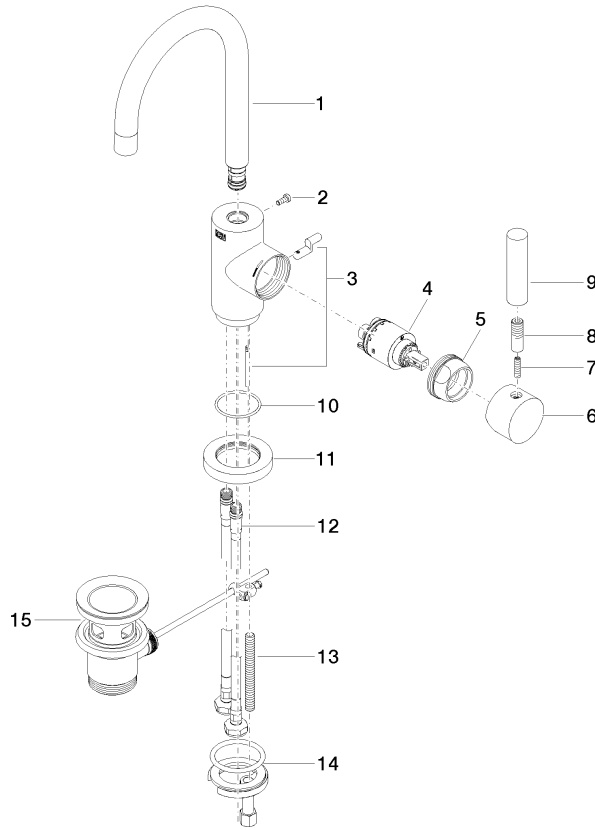



TARA Single-lever basin mixer with pop-up waste - Brushed Platinum

TARA

33 500 882

Spare parts list

Product version from 4/1/2024

No.	Item Number	Name	Quantity used	Delivery time
	90 28 22 371 00-06	spout	16	10