

















**META Single-lever basin mixer without pop-up waste - Brushed Durabronze  
(23kt Gold)**

META

33 525 660



- 105mm projection
- fixed spout
- circular, air-enriched flow
- height of mixer 138 mm
- height up to aerator 57 mm
- hole diameter 35 mm
- rosette Ø 50 mm optional
- 2x screw-in M 8 x 1 pressure hose, leak-tested
- max. flow 5.7 l/min
- lead-free
- This product can help a building meet the requirements of Green Building Rating Systems, e.g. LEED®, BREEAM®, DGNB
- WRAS 2003058

	Brushed Durabronze (23kt Gold)	33 525 660-28
	Chrome	33 525 660-00
	Brushed Platinum	33 525 660-06
	Platinum	33 525 660-08
	Dark Chrome	33 525 660-19
	Light Gold	33 525 660-26
	Brushed Light Gold	33 525 660-27
	Red	33 525 660-29
	Orange	33 525 660-30
	Dark Green	33 525 660-31
	Matte Black	33 525 660-33
	Brushed Bronze	33 525 660-42
	Brushed Champagne (22kt Gold)	33 525 660-46
	Champagne (22kt Gold)	33 525 660-47
	Brushed Chrome	33 525 660-93
	Brushed Dark Platinum	33 525 660-99

33 525 660  
mm [inches]

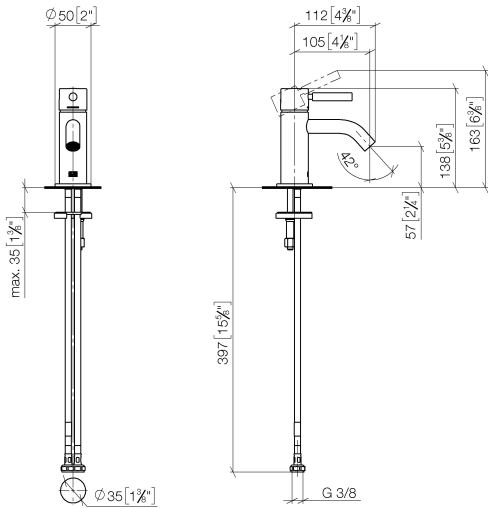

**Flow rate chart**



**Codes & Standards**

DIN 4109

EN 817

ISO 3822

Scottish Water  
Byelaws

UK Water Supply  
Regulations

Ü-Zeichen



**META Single-lever basin mixer without pop-up waste - Brushed Durabronz  
(23kt Gold)**

---

META

33 525 660

Certificates

---

WRAS\_2003

LGA\_29

DVGW\_DW-  
6506DNO



# META Single-lever basin mixer without pop-up waste - Brushed Durabronz (23kt Gold)

META

33 525 660

Product version up to 1/23/2020

## Product version from 1/23/2020

Parts for other finishes can be found here: [Chrome](#)

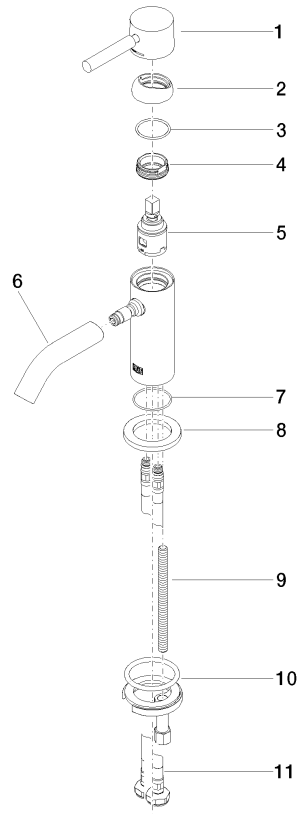



**META Single-lever basin mixer without pop-up waste - Brushed Durabronze  
(23kt Gold)**

META

33 525 660

**Spare parts list**

Product version up to 1/23/2020

**Product version from 1/23/2020**

No.	Item Number	Name	Quantity used	Delivery time
	90 20 66 009 00-28	handle	12	20