

















33 525 660



- 105mm projection
- fixed spout
- circular, air-enriched flow
- height of mixer 138 mm
- height up to aerator 57 mm
- hole diameter 35 mm
- rosette Ø 50 mm optional
- 2x screw-in M 8 x 1 pressure hose, leak-tested
- max. flow 5.7 l/min
- lead-free
- This product can help a building meet the requirements of Green Building Rating Systems, e.g. LEED®, BREEAM®, DGNB
- WRAS 2003058

	Brushed Dark Platinum	33 525 660-99
	Chrome	33 525 660-00
	Brushed Platinum	33 525 660-06
	Platinum	33 525 660-08
	Dark Chrome	33 525 660-19
	Light Gold	33 525 660-26
	Brushed Light Gold	33 525 660-27
	Brushed Durabronze (23kt Gold)	33 525 660-28
	Red	33 525 660-29
	Orange	33 525 660-30
	Dark Green	33 525 660-31
	Matte Black	33 525 660-33
	Brushed Bronze	33 525 660-42
	Brushed Champagne (22kt Gold)	33 525 660-46
	Champagne (22kt Gold)	33 525 660-47
	Brushed Chrome	33 525 660-93

33 525 660

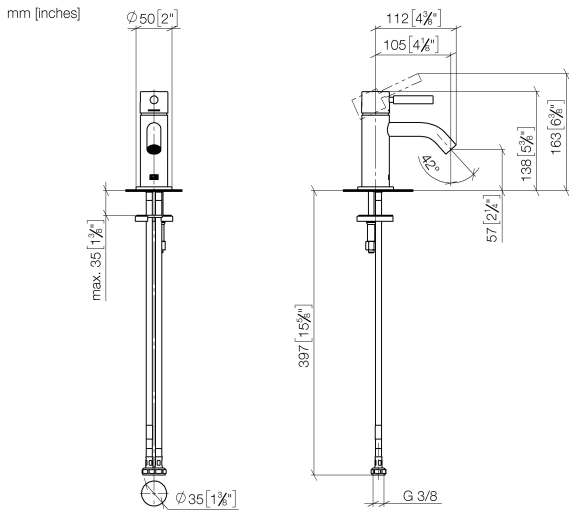

**Flow rate chart**



**Codes & Standards**

DIN 4109

EN 817

ISO 3822

Scottish Water  
Byelaws

UK Water Supply  
Regulations

Ü-Zeichen



# META Single-lever basin mixer without pop-up waste - Brushed Dark Platinum

META

33 525 660

## Certificates

WRAS\_2003

LGA\_29

DVGW\_DW-  
6506DNO

33 525 660

Product version up to 1/23/2020

**Product version from 1/23/2020**

Parts for other  
finishes can be found  
here: [Chrome](#)

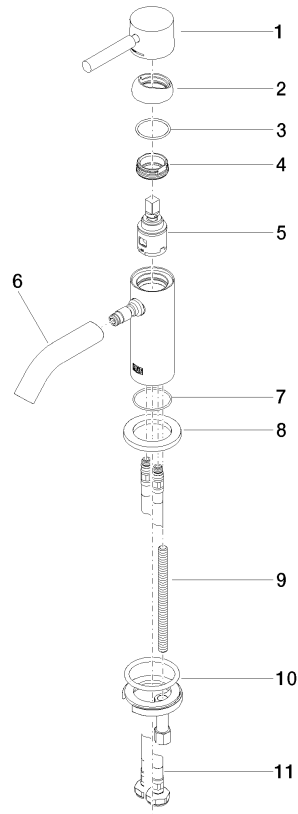



# META Single-lever basin mixer without pop-up waste - Brushed Dark Platinum

META

33 525 660

## Spare parts list

Product version up to 1/23/2020

### Product version from 1/23/2020

No.	Item Number	Name	Quantity used	Delivery time
	90 20 66 009 00-99	handle	12	30