













34 459 980



Fits: IMO, MEM, CL.1, CYO

- shower with fixed riser projection 453mm
- overhead shower: rain flow
- rain shower 300 x 240mm
- rain shower with anti-scale system
- max. rainshower flow 20 l/min
- Function from: 12 l/min
- rotary diverter with volume control and shut-off function
- slide-on rosettes Ø 70 mm
- height of fittings up to rain shower (bottom edge) 1009mm
- height of fittings up to top edge of elbow 1150mm
- gauge 150 mm - 13 mm
- metal shower hose 1750mm with integrated anti-twist protection
- 1/2" connection
- slide bar
- Pipe diameter 23.5 mm
- quick clearing
- WRAS 2204013

This article does not include a hand shower!
Intrinsic protection against back flow.

	Brushed Platinum	34 459 980-06
	Chrome	34 459 980-00
	Platinum	34 459 980-08
	Dark Chrome	34 459 980-19
	Brushed Light Gold	34 459 980-27
	Brushed Durabronze (23kt Gold)	34 459 980-28
	Matte Black	34 459 980-33
		34 459 980-39
	Brushed Bronze	34 459 980-42
		34 459 980-43
	Brushed Champagne (22kt Gold)	34 459 980-46
	Champagne (22kt Gold)	34 459 980-47
	Brushed Chrome	34 459 980-93
	Brushed Dark Platinum	34 459 980-99

Showerpipe with shower thermostat without hand shower - Brushed Platinum

IMO

34 459 980

Required miscellaneous

	Hand shower FlowReduce - Brushed Platinum	28 012 979-06 0010
---	--	-----------------------

Required miscellaneous

	Hand shower - Brushed Platinum	28 016 979-06
---	---------------------------------------	---------------

Required miscellaneous

	Hand shower FlowReduce - Brushed Platinum	28 016 979-06 0010
---	--	-----------------------

Required miscellaneous

	Hand shower FlowReduce - Brushed Platinum	28 018 979-06 0010
---	--	-----------------------

Required miscellaneous

	SERIES-VARIOUS Hand shower FlowReduce - Brushed Platinum	28 029 979-06 0010
---	---	-----------------------

Required miscellaneous

	SERIES-VARIOUS Hand shower FlowReduce - Brushed Platinum	28 025 979-06 0010
---	---	-----------------------

Required miscellaneous

	Hand shower - Brushed Platinum	28 017 979-06
---	---------------------------------------	---------------

Required miscellaneous

	Hand shower - Brushed Platinum	28 012 979-06
---	---------------------------------------	---------------

Required miscellaneous

	Hand shower - Brushed Platinum	28 018 979-06
---	---------------------------------------	---------------

Required miscellaneous

	SERIES-VARIOUS Hand shower - Brushed Platinum	28 029 979-06
---	--	---------------

Required miscellaneous

	SERIES-VARIOUS Hand shower FlowReduce - Brushed Platinum	28 027 979-06 0010
---	---	-----------------------

34 459 980

mm [inches]
1:10

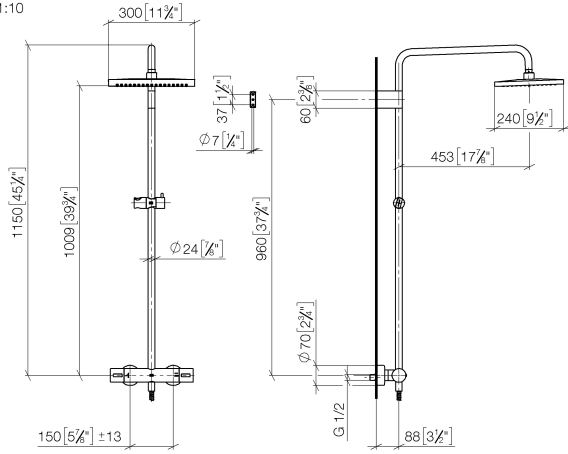

Flow rate chart

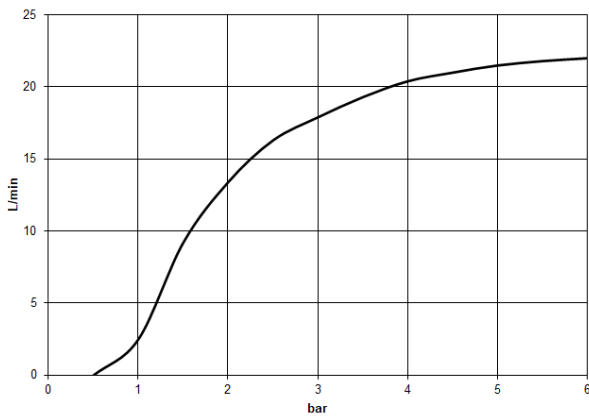

Codes & Standards

DIN 4109

EN 1717

ISO 3822

Scottish Water
Byelaws

UK Water Supply
Regulations

Ü-Zeichen



Showerpipe with shower thermostat without hand shower - Brushed Platinum

IMO

34 459 980

Certificates

WRAS_2204

LGA_38

Belgaqua_21-032-2

34 459 980

Product version from 6/1/2024

Parts for other finishes can be found here: [Chrome](#)

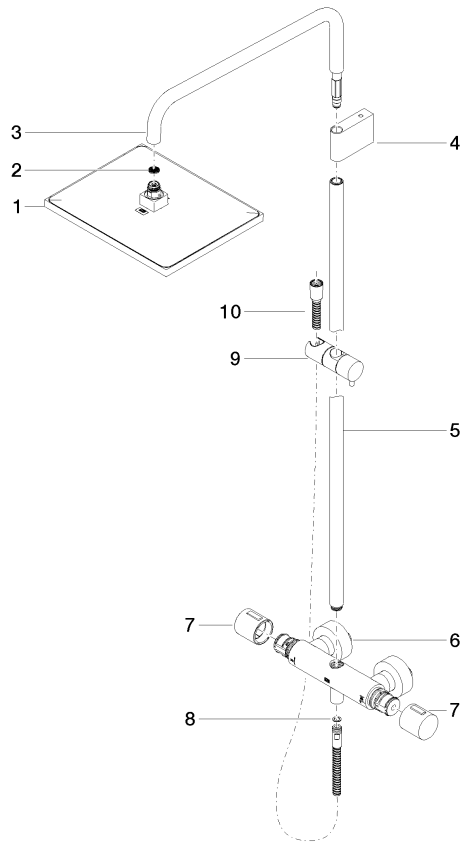



Showerpipe with shower thermostat without hand shower - Brushed Platinum

IMO

34 459 980

Spare parts list

Product version from 6/1/2024

No.	Item Number	Name	Quantity used	Delivery time
	04 12 05 063 00-06	shower	11	10