

# CYO Wall-mounted basin mixer without pop-up waste - Brushed Platinum

CYO







36 707 811



- 160mm projection
- fixed spout
- rectangular, air-enriched flow
- hole diameter valve 37 mm
- hole diameter spout 37 mm
- handle Ø 60mm
- max. flow 4.5 l/min
- lead-free
- This product can help a building meet the requirements of Green Building Rating Systems, e.g. LEED®, BREEAM®, DGNB
- WRAS 2111006

**NOTE: The handle inserts must be ordered separately from the fittings!**

NOTE: The handle inserts must be ordered separately from the fittings!

	Brushed Platinum	36 707 811-06
	Chrome	36 707 811-00
	Dark Chrome	36 707 811-19
	Brushed Durabress (23kt Gold)	36 707 811-28
	Platinum / Brushed Platinum	36 707 811-36
	Durabress / Brushed Durabress (23kt Gold)	36 707 811-38
	Brushed Dark Platinum	36 707 811-99

## Required miscellaneous



- Concealed wall-mounted mixer centred spout -** 35 700 970 90
- max. recess depth 145 mm
  - min. recess depth 85 mm

## Required miscellaneous



- Concealed wall-mounted mixer variable positioning -** 35 720 970 90
- max. recess depth 145 mm
  - min. recess depth 85 mm

36 707 811

mm [inches]

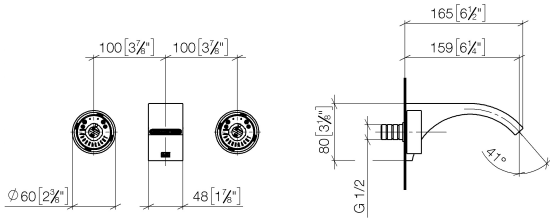

Flow rate chart

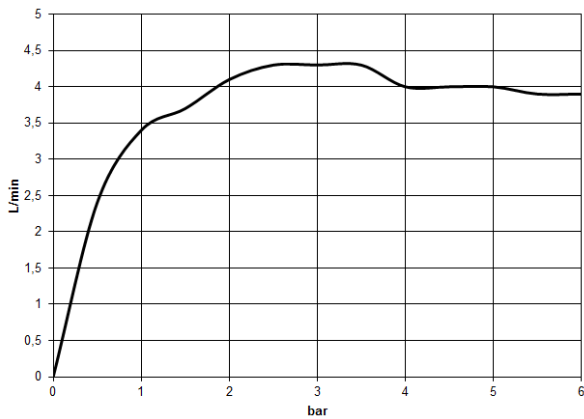

Codes & Standards

ASME A112.18.1	cUPC	DIN 4109	EPA WaterSense
ISO 3822	NSF372	NSF61	Scottish Water Byelaws
UK Water Supply Regulations	Ü-Zeichen	WaterSense	



CYO Wall-mounted basin mixer without pop-up waste - Brushed Platinum

CYO

36 707 811

Certificates

IAPMO\_4976

WRAS\_2111

IAPMO\_8834

IAPMO\_6397

IAPMO\_N-4976

LGA\_38

36 707 811

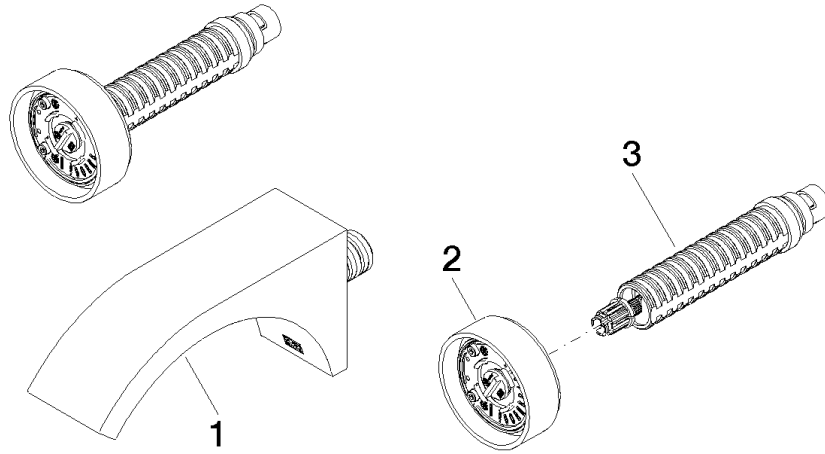



## CYO Wall-mounted basin mixer without pop-up waste - Brushed Platinum

CYO

36 707 811

### Spare parts list

No.	Item Number	Name	Quantity used	Delivery time
	13 800 811-06	CYO Wall-mounted basin spout without pop-up waste - Brushed Platinum	3	10