





LISSÉ Wall-mounted single-lever basin mixer without pop-up waste - Matte Black

LISSÉ

36 860 845



- 170mm projection
- fixed spout
- circular, air-enriched flow
- hole diameter spout 37 mm
- hole diameter single-lever mixer 57 mm
- rosette 78 x 78 mm
- max. flow 5.7 l/min
- lead-free
- This product can help a building meet the requirements of Green Building Rating Systems, e.g. LEED®, BREEAM®, DGNB
- WRAS 2107018

	Matte Black	36 860 845-33
	Chrome	36 860 845-00
	Brushed Platinum	36 860 845-06
	Dark Chrome	36 860 845-19
	Brushed Light Gold	36 860 845-27
	Brushed Chrome	36 860 845-93
	Brushed Dark Platinum	36 860 845-99

Required miscellaneous



Concealed wall-mounted single-lever mixer on right - 35 816 970 90
 ●NOTE:Not suitable for concealed installation.Connection by means of angle valves, mounted with screws to back wall.

Required miscellaneous



Concealed wall-mounted single-lever mixer - 35 860 970 90
 ●max. recess depth 95 mm
 ●min. recess depth 75 mm



LISSÉ Wall-mounted single-lever basin mixer without pop-up waste - Matte Black

LISSÉ

36 860 845
mm [inches]

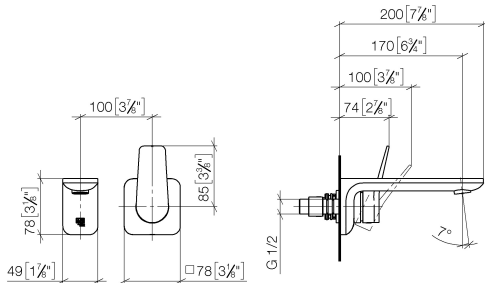

Flow rate chart

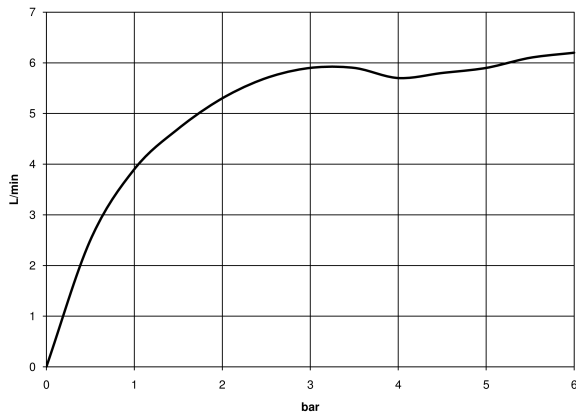

Codes & Standards

EN 817

EPA WaterSense

NSF372

NSF61

Scottish Water
Byelaws

UK Water Supply
Regulations

WaterSense





LISSÉ Wall-mounted single-lever basin mixer without pop-up waste - Matte Black

LISSÉ

36 860 845

Certificates

WRAS_2107

IAPMO_8834

IAPMO_6397

IAPMO_N-4976

DVGW_DW-
6512DN0

36 860 845

Product version from 4/1/2024

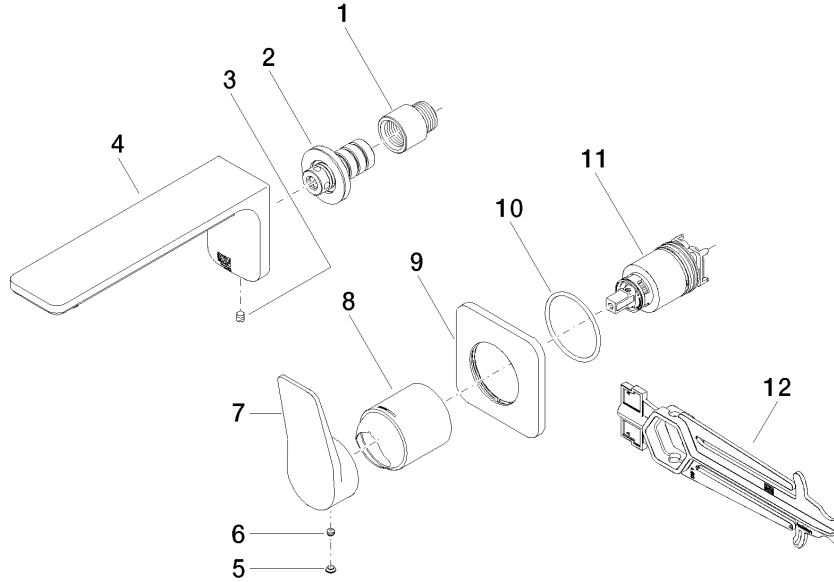



LISSÉ Wall-mounted single-lever basin mixer without pop-up waste - Matte Black

LISSÉ

36 860 845

Spare parts list

Product version from 4/1/2024

No.	Item Number	Name	Quantity used	Delivery time
	09 24 03 072 10 90	nipple	12	2