



36 861 670



- 170mm projection
- fixed spout
- rectangular, air-enriched flow
- hole diameter spout 37 mm
- hole diameter single-lever mixer 57 mm
- rosette for spout 80 x 60mm
- rosette for mixer 80 x 80mm
- max. flow 5.7 l/min
- lead-free
- This product can help a building meet the requirements of Green Building Rating Systems, e.g. LEED®, BREEAM®, DGNB
- WRAS 2107018

	Chrome	36 861 670-00
	Brushed Platinum	36 861 670-06
	Brushed Chrome	36 861 670-93

Required miscellaneous



Concealed wall-mounted single-lever mixer mixer on right - 35 816 970 90
 ●NOTE:Not suitable for concealed installation.Connection by means of angle valves, mounted with screws to back wall.

Required miscellaneous



Concealed wall-mounted single-lever mixer - 35 860 970 90
 ●max. recess depth 95 mm
 ●min. recess depth 80 mm

36 861 670

mm [inches]

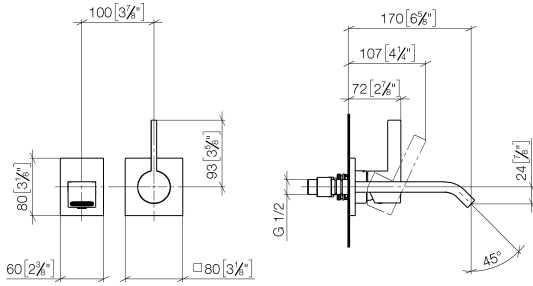

Flow rate chart

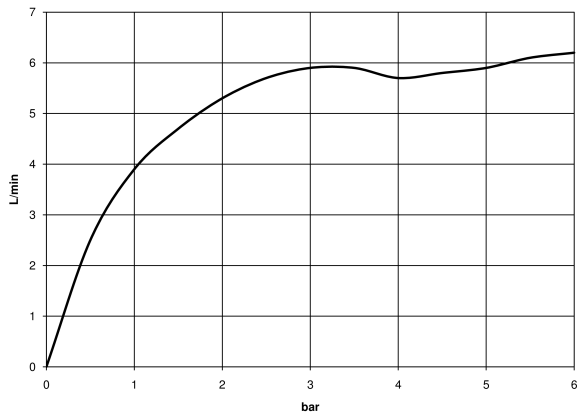

Codes & Standards

DIN 4109

EN 817

ISO 3822

Scottish Water
Byelaws

UK Water Supply
Regulations

Ü-Zeichen



IMO Wall-mounted single-lever basin mixer without pop-up waste - Chrome

IMO

36 861 670

Certificates

WRAS_2107

LGA_29

DVGW_DW-
6512DN0

36 861 670

Product version from 4/1/2024

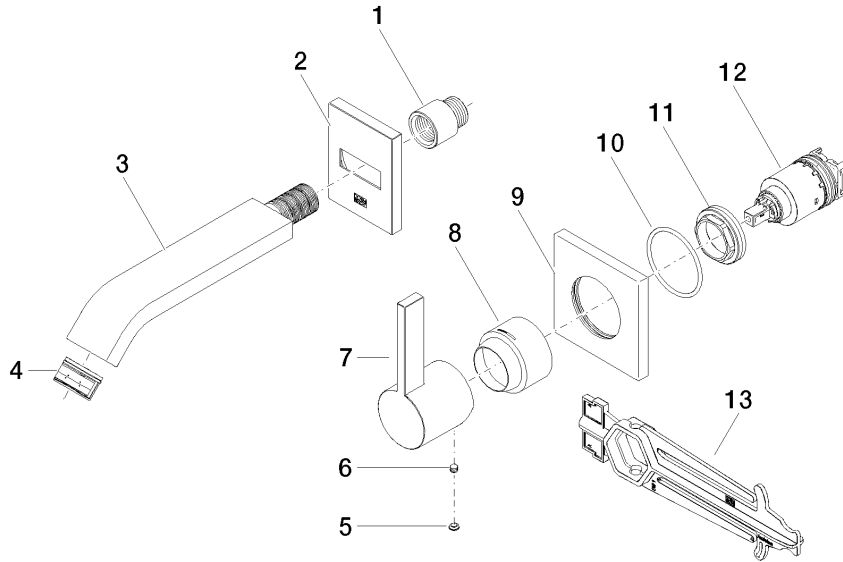



IMO Wall-mounted single-lever basin mixer without pop-up waste - Chrome

IMO

36 861 670

Spare parts list

Product version from 4/1/2024

No.	Item Number	Name	Quantity used	Delivery time
	09 24 03 072 10 90	nipple	13	2