

MEM Wall-mounted single-lever basin mixer without pop-up waste - Brushed Platinum

36 861 782



- 207mm projection
- fixed spout
- rectangular, air-enriched flow
- hole diameter spout 37 mm
- hole diameter single-lever mixer 57 mm
- rosette for spout 80 x 60mm
- rosette for mixer 80 x 80mm
- max. flow 5.7 l/min
- lead-free
- This product can help a building meet the requirements of Green Building Rating Systems, e.g. LEED®, BREEAM®, DGNB
- WRAS

	Brushed Platinum	36 861 782-06
	Chrome	36 861 782-00
	Platinum	36 861 782-08
	Dark Chrome	36 861 782-19
	Brushed Durabrass (23kt Gold)	36 861 782-28
	Brushed Champagne (22kt Gold)	36 861 782-46
	Champagne (22kt Gold)	36 861 782-47
	Brushed Dark Platinum	36 861 782-99

Required miscellaneous



- Concealed wall-mounted single-lever mixer mixer on right -** 35 816 970 90
- NOTE: Not suitable for concealed installation. Connection by means of angle valves, mounted with screws to back wall.

Required miscellaneous



- Concealed wall-mounted single-lever mixer -** 35 860 970 90
- max. recess depth mm
 - min. recess depth mm
 - mixer can be placed above, to the left or to the right of the spout.



MEM Wall-mounted single-lever basin mixer without pop-up waste - Brushed Platinum

36 861 782
mm [inches]

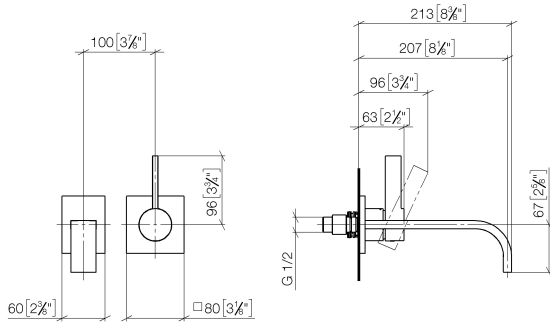

Flow rate chart

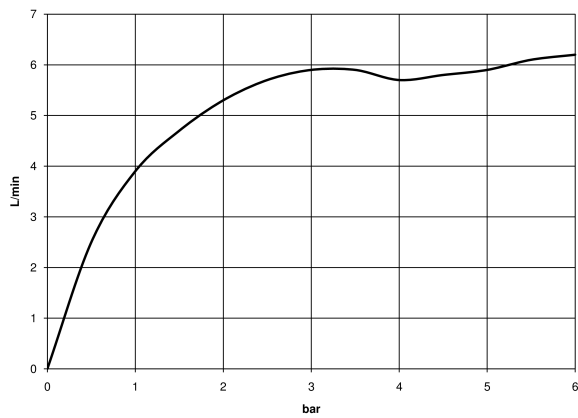

Codes & Standards

DIN 4109

EN 817

ISO 3822

Scottish Water
Byelaws

UK Water Supply
Regulations

Ü-Zeichen



MEM Wall-mounted single-lever basin mixer without pop-up waste - Brushed Platinum

36 861 782

Certificates

LGA_29

DVGW_DW-
6512DN0

WRAS_2107

MEM Wall-mounted single-lever basin mixer without pop-up waste - Brushed Platinum

36 861 782

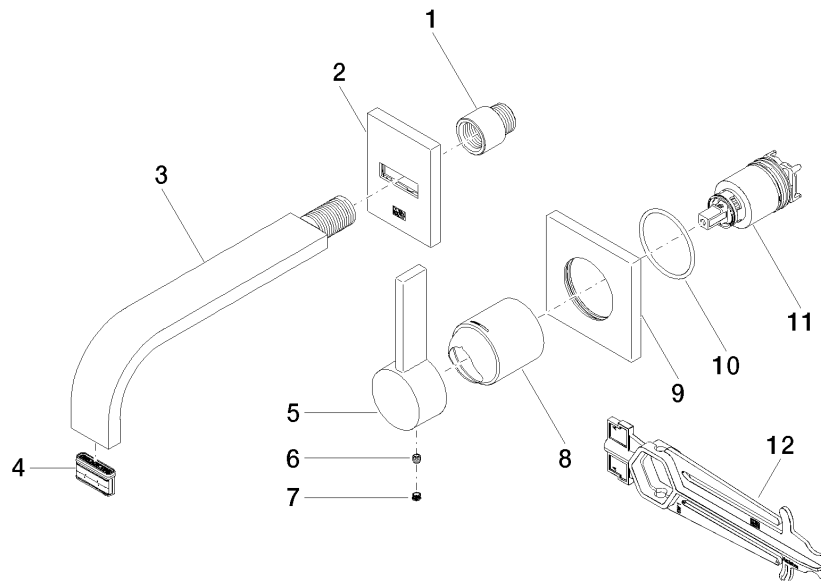

Spare parts list

No.	Item Number	Name	Quantity used	Delivery time
1	09 24 03 072 10 90	nipple	1	2
2	90 27 78 038 00-06	rosette	1	10
3	04 28 22 149 10-06	spout	1	10
4	90 29 03 109 00 90	aerator	1	2
5	09 20 78 058-06	handle	1	10
6	90 31 11 030 00 90	pin	1	2
7	90 31 20 109 00 90	plug	1	2
8	09 11 02 288-06	cover	1	10
9	09 27 78 039-06	rosette	1	10
10	90 14 10 049 00 90	seal	1	2
11	90 15 05 064 01 90	cartridge	1	2
12	90 30 09 064 00 90	key	1	2