



CYO Wall-mounted single-lever basin mixer without pop-up waste - Brushed Durabross (23kt Gold)

CYO

36 861 811



- 190mm projection
- fixed spout
- rectangular, air-enriched flow
- hole diameter spout 37 mm
- hole diameter single-lever mixer 57 mm
- rosette for mixer 80 x 80mm
- max. flow 4.5 l/min
- lead-free
- This product can help a building meet the requirements of Green Building Rating Systems, e.g. LEED®, BREEAM®, DGNB
- WRAS 2107047

	Brushed Durabross (23kt Gold)	36 861 811-28
	Chrome	36 861 811-00
	Brushed Platinum	36 861 811-06
	Dark Chrome	36 861 811-19
	Brushed Dark Platinum	36 861 811-99

Required miscellaneous



Concealed wall-mounted single-lever mixer - 35 860 970 90

- max. recess depth 95 mm
- min. recess depth 80 mm



CYO Wall-mounted single-lever basin mixer without pop-up waste - Brushed Durabronz (23kt Gold)

CYO

36 861 811
mm [inches]

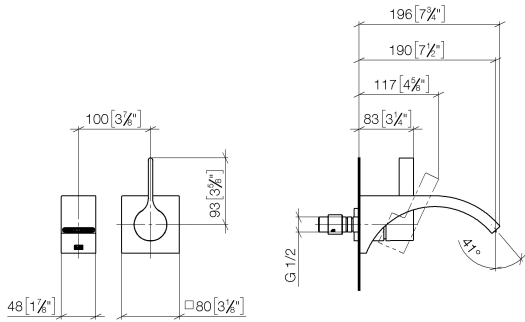

Flow rate chart



Codes & Standards

DIN 4109

ISO 3822

NSF372

NSF61

Scottish Water
Byelaws

UK Water Supply
Regulations

Ü-Zeichen



CYO Wall-mounted single-lever basin mixer without pop-up waste - Brushed
Durabross (23kt Gold)

CYO

36 861 811

Certificates

LGA_38

WRAS_2107

IAPMO_6397

IAPMO_N-4976



CYO Wall-mounted single-lever basin mixer without pop-up waste - Brushed Durabronz (23kt Gold)

CYO

36 861 811

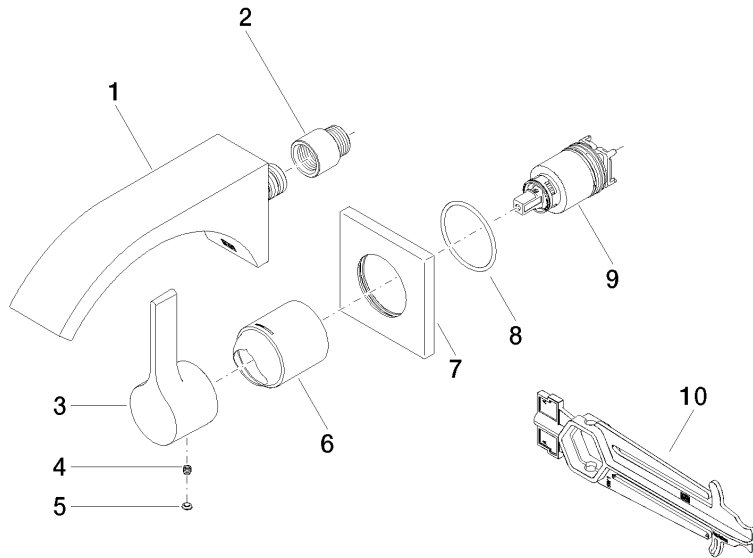



CYO Wall-mounted single-lever basin mixer without pop-up waste - Brushed Durabross (23kt Gold)

CYO

36 861 811

Spare parts list

No.	Item Number	Name	Quantity used	Delivery time
	13 805 811-28	CYO Wall-mounted basin spout without pop-up waste - Brushed Durabross (23kt Gold)	10	20