





EDITION PRO Tissue holder with cover - Matte Black

83 510 626



- width 150mm
- height 95 mm
- rosette Ø 40 mm
- 40mm projection

	Matte Black	83 510 626-33
	Chrome	83 510 626-00
	Brushed Chrome	83 510 626-93



EDITION PRO Tissue holder with cover - Matte Black

83 510 626

mm [inches]

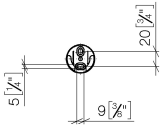
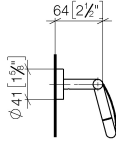
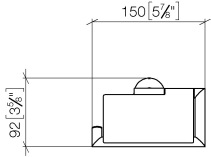

EDITION PRO Tissue holder with cover - Matte Black

83 510 626

Parts for other
finishes can be found
here: [Chrome](#)

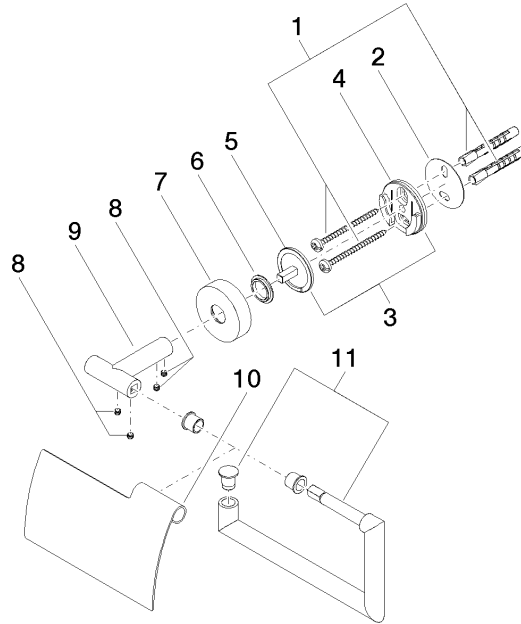



EDITION PRO Tissue holder with cover - Matte Black

83 510 626

Spare parts list

No.	Item Number	Name	Quantity used	Delivery time
	05 30 31 025 00 90	fixing set	14	2