

ST 050 203 2979



Fits: IMO, LISSÉ, META

- slide bar
- Pipe diameter 18 mm
- gauge 853 mm
- metal shower hose 1750mm with integrated anti-twist protection
- shower hose connector 3/8"
- Three or five settings: COMPACT RAIN, COMPACT SOFT FLOW, COMPACT AQUAPRESSURE FLOW, max. flow rate 6.8 l/min (at 3 bar)
- Function from: 6 l/min
- spray head Ø 100mm
- This product can help a building meet the requirements of Green Building Rating Systems, e.g. LEED®, BREEAM®, DGNB

| | | |
|--|-------------------------------|-------------------------|
|  | Chrome | ST 050 203 2979-00 0010 |
|  | Chrome | ST 050 203 9979-00 |
|  | Brushed Platinum | ST 050 203 9979-06 |
|  | Brushed Platinum | ST 050 203 2979-06 0010 |
|  | Platinum | ST 050 203 9979-08 |
|  | Platinum | ST 050 203 2979-08 0010 |
|  | Dark Chrome | ST 050 203 9979-19 |
|  | Dark Chrome | ST 050 203 2979-19 0010 |
|  | Light Gold | ST 050 203 9979-26 |
|  | Light Gold | ST 050 203 2979-26 0010 |
|  | Brushed Light Gold | ST 050 203 9979-27 |
|  | Brushed Light Gold | ST 050 203 2979-27 0010 |
|  | Brushed Durabrass (23kt Gold) | ST 050 203 9979-28 |
|  | Brushed Durabrass (23kt Gold) | ST 050 203 2979-28 0010 |
|  | Matte Black | ST 050 203 9979-33 |
|  | Matte Black | ST 050 203 2979-33 0010 |
|  | Brushed Bronze | ST 050 203 9979-42 |
|  | Brushed Bronze | ST 050 203 2979-42 0010 |
|  | Brushed Champagne (22kt Gold) | ST 050 203 9979-46 |
|  | Brushed Champagne (22kt Gold) | ST 050 203 2979-46 0010 |
|  | Champagne (22kt Gold) | ST 050 203 9979-47 |
|  | Champagne (22kt Gold) | ST 050 203 2979-47 0010 |
|  | Brushed Chrome | ST 050 203 9979-93 |
|  | Brushed Chrome | ST 050 203 2979-93 0010 |
|  | Brushed Dark Platinum | ST 050 203 9979-99 |
|  | Brushed Dark Platinum | ST 050 203 2979-99 0010 |

ST 050 203 2979

Individual components of this set

You need the following components for this set



1x 26 413 979-00



1x 28 018 979-00 0010











ST 050 203 2979



Fits: IMO, LULU, MEM, TARA, CL.1, LISSÉ,
VAIA, META, CYO

- slide bar
- Pipe diameter 18 mm
- gauge 853 mm
- metal shower hose 1750mm with integrated anti-twist protection
- shower hose connector 3/8"

This article does not include a hand shower!

| | | |
|--|-------------------------------------|---------------|
|  | Chrome | 26 413 979-00 |
|  | Brushed Platinum | 26 413 979-06 |
|  | Platinum | 26 413 979-08 |
|  | Dark Chrome | 26 413 979-19 |
|  | Light Gold | 26 413 979-26 |
|  | Brushed Light Gold | 26 413 979-27 |
|  | Brushed Durabronze (23kt Gold) | 26 413 979-28 |
|  | Matte Black | 26 413 979-33 |
|  | Brushed Bronze | 26 413 979-42 |
|  | Brushed Champagne (22kt Gold) | 26 413 979-46 |
|  | Champagne (22kt Gold) | 26 413 979-47 |
|  | Brushed Chrome | 26 413 979-93 |
|  | Brushed Dark Platinum | 26 413 979-99 |

ST 050 203 2979

Recommended miscellaneous

| | | |
|---|--|---------------|
|  | Concealed wall elbow - ●max. recess depth 163 mm ●min. recess depth 90 mm | 35 085 970 90 |
|---|--|---------------|

Recommended miscellaneous

| | | |
|---|----------------------------------|---------------|
|  | LISSE Wall elbow - Chrome | 28 450 845-00 |
|---|----------------------------------|---------------|

Required miscellaneous

| | | |
|---|--|---------------|
|  | Hand shower - Chrome ●Max. flow rate 15 l/min (at 3 bar) | 28 017 979-00 |
|---|--|---------------|

Required miscellaneous

| | | |
|---|--|---------------|
|  | Hand shower - Chrome ●Max. flow rate 15 l/min (at 3 bar) | 28 016 979-00 |
|---|--|---------------|

Required miscellaneous

| | | |
|---|--|-----------------------|
|  | Hand shower FlowReduce - Chrome ●Max. flow rate 6.8 l/min (at 3 bar) | 28 016 979-00 0010 |
|---|--|-----------------------|

Required miscellaneous

| | | |
|---|--|-----------------------|
|  | Hand shower FlowReduce - Chrome ●Max. flow rate 6.8 l/min (at 3 bar) | 28 018 979-00 0010 |
|---|--|-----------------------|

Recommended miscellaneous

| | | |
|---|----------------------------|---------------|
|  | Wall elbow - Chrome | 28 450 980-00 |
|---|----------------------------|---------------|

Required miscellaneous

| | | |
|---|--|---------------|
|  | Hand shower - Chrome ●Max. flow rate 15 l/min (at 3 bar) | 28 015 979-00 |
|---|--|---------------|

Required miscellaneous

| | | |
|---|--|-----------------------|
|  | Hand shower FlowReduce - Chrome ●Max. flow rate 6.8 l/min (at 3 bar) | 28 012 979-00 0010 |
|---|--|-----------------------|

Required miscellaneous

| | | |
|---|--|---------------|
|  | Hand shower - Chrome ●Max. flow rate 15 l/min (at 3 bar) | 28 012 979-00 |
|---|--|---------------|

Required miscellaneous

| | | |
|---|--|---------------|
|  | Hand shower - Chrome ●Max. flow rate 15 l/min (at 3 bar) | 28 018 979-00 |
|---|--|---------------|

ST 050 203 2979

mm [inches]

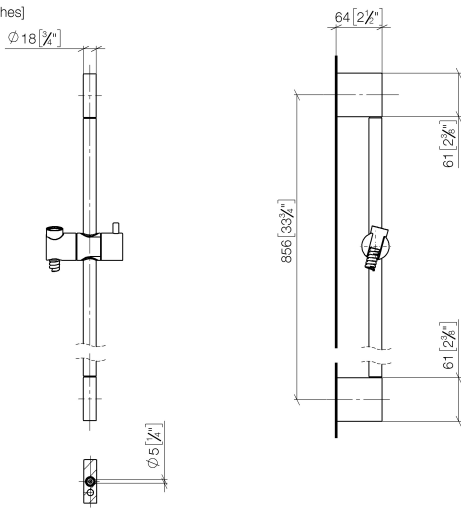

Certificates

WRAS_2009048. ACS_20 ACC LY 738. IAPMO_4976 (1).

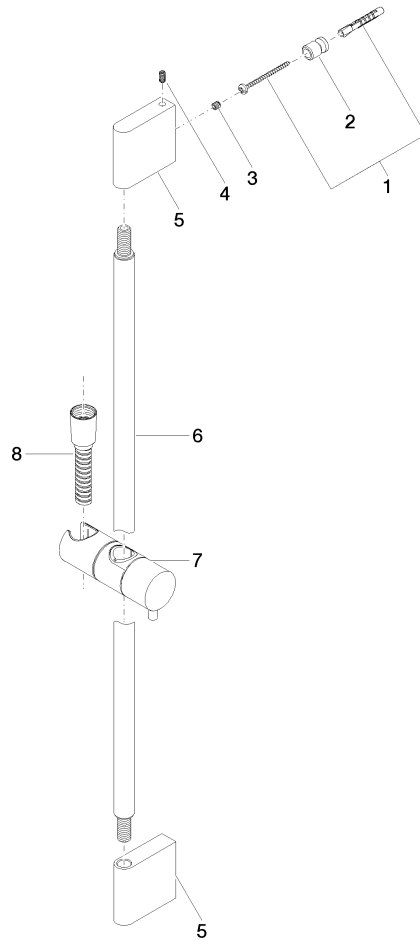

Spare parts list

| No. | Item Number | Name | Quantity used | Delivery time |
|-----|--------------------|--|---------------|---------------|
| 1 | 05 17 20 726 02 90 | fixing set | 2 | 2 |
| 2 | 08 17 20 726 90 | holder | 2 | 2 |
| 3 | 09 31 11 049 90 | pin | 2 | 2 |
| 4 | 04 31 11 113 00 90 | pin | 2 | 2 |
| 5 | 08 17 97 054-00 | holder | 2 | 10 |
| 6 | 90 28 22 597 00-00 | holder | 1 | 10 |
| 7 | 12 580 970-00 | Slide unit - Chrome | 1 | 10 |
| 8 | 28 322 970-00 | Metal shower hose 1/2" x 3/8" x 1750 mm - Chrome | 1 | 2 |





























ST 050 203 2979



- Three or five settings: COMPACT RAIN, COMPACT SOFT FLOW, COMPACT AQUAPRESSURE FLOW, max. flow rate 6.8 l/min (at 3 bar)
- with anti-scale system
- spray head Ø 100mm
- 1/2" connection
- Function from: 6 l/min
- This product can help a building meet the requirements of Green Building Rating Systems, e.g. LEED®, BREEAM®, DGNB

Intrinsic protection against back flow.

Fits: IMO, LULU, MADISON, MEM, TARA, CL.1, LISSÉ, VAIA, META, CYO

| | | |
|--|--------------------------------|--------------------|
|  | Chrome | 28 018 979-00 0010 |
|  | Chrome | 28 018 979-00 |
|  | Brushed Platinum | 28 018 979-06 |
|  | Brushed Platinum | 28 018 979-06 0010 |
|  | Platinum | 28 018 979-08 |
|  | Platinum | 28 018 979-08 0010 |
|  | Dark Brass matt | 28 018 979-16 0010 |
|  | Dark Bronze matt | 28 018 979-17 0010 |
|  | Dark Chrome | 28 018 979-19 |
|  | Dark Chrome | 28 018 979-19 0010 |
|  | Light Gold | 28 018 979-26 0010 |
|  | Light Gold | 28 018 979-26 |
|  | Brushed Light Gold | 28 018 979-27 0010 |
|  | Brushed Light Gold | 28 018 979-27 |
|  | Brushed Durabronze (23kt Gold) | 28 018 979-28 |
|  | Brushed Durabronze (23kt Gold) | 28 018 979-28 0010 |
|  | Matte Black | 28 018 979-33 |
|  | Matte Black | 28 018 979-33 0010 |
|  | Brushed Bronze | 28 018 979-42 |
|  | Brushed Bronze | 28 018 979-42 0010 |
|  | Brushed Champagne (22kt Gold) | 28 018 979-46 |
|  | Brushed Champagne (22kt Gold) | 28 018 979-46 0010 |
|  | Champagne (22kt Gold) | 28 018 979-47 |
|  | Champagne (22kt Gold) | 28 018 979-47 0010 |
|  | Brushed Chrome | 28 018 979-93 |
|  | Brushed Chrome | 28 018 979-93 0010 |
|  | Brushed Dark Platinum | 28 018 979-99 |
|  | Brushed Dark Platinum | 28 018 979-99 0010 |



Shower set - Chrome

IMO

ST 050 203 2979



Shower set - Chrome

IMO

ST 050 203 2979



Shower set - Chrome

IMO

ST 050 203 2979

ST 050 203 2979

mm [inches]

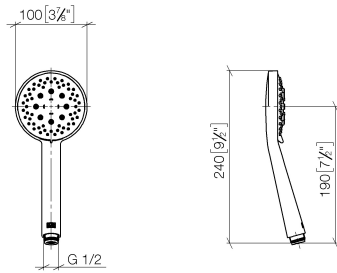

Flow rate chart

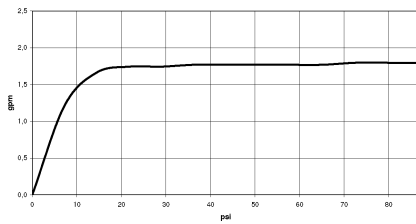

Certificates

LGA_29984.

Spare parts list

| No. | Item Number | Name | Quantity used | Delivery time |
|-----|-----------------|-------|---------------|---------------|
| 1 | 09 23 01 039 90 | sieve | 1 | 2 |