

MADISON Three-hole basin mixer with pop-up waste - Brushed Platinum







MADISON

20 700 360



- 135mm projection
- fixed spout
- circular, air-enriched flow
- height of mixer 72 mm
- height up to aerator 40 mm
- hole diameter valve 32 mm
- hole diameter spout 35 mm
- without rosette
- 2x 1/2" x 1/2" high pressure hose
- max. flow 7 l/min
- lead-free
- This product can help a building meet the requirements of Green Building Rating Systems, e.g. LEED®, BREEAM®, DGNB
- WRAS 1512009

Only suitable for basins with an overflow.

	Brushed Platinum	20 700 360-06
	Chrome	20 700 360-00
	Platinum	20 700 360-08
	Durabress (23kt Gold)	20 700 360-09
	Brushed Durabress (23kt Gold)	20 700 360-28
	Brushed Dark Platinum	20 700 360-99

Recommended miscellaneous



- High pressure hoses -**
- 2x 3/8" x 1/2" x 500mm high pressure hose

12 506 970 90

20 700 360

mm [inches]

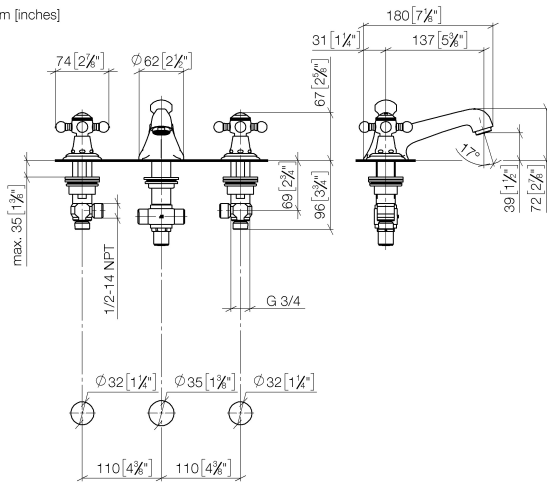

Flow rate chart

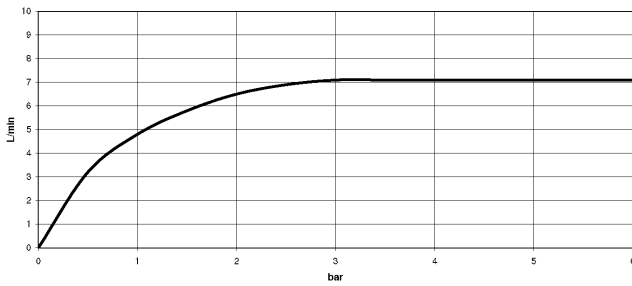

Codes & Standards

DIN 4109

EN 200

Executive Order
no. 1007

ISO 3822

Scottish Water
Byelaws

UK Water Supply
Regulations

Ü-Zeichen

VA-Zeichen



MADISON Three-hole basin mixer with pop-up waste - Brushed Platinum

MADISON

20 700 360

Certificates

ETA_17

WRAS_1512

GDV_0400

LGA_8

WRAS_240602

20 700 360

Product version from 7/31/2009

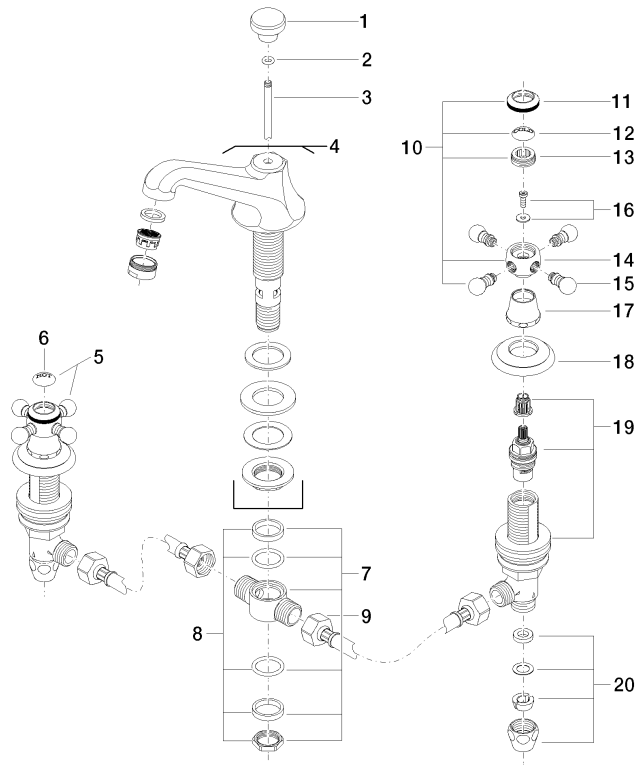

21 ————— Ablaufgarnitur 04.11.01.001.00.FF



MADISON Three-hole basin mixer with pop-up waste - Brushed Platinum

MADISON

20 700 360

Spare parts list

Product version from 7/31/2009

No.	Item Number	Name	Quantity used	Delivery time
	09 20 36 030-06	handle	37	10