

20 710 892



- 135mm projection
- pivotable spout 360°
- circular, air-enriched flow
- height of mixer 270 mm
- height up to aerator 161 mm
- hole diameter valve 32 mm
- hole diameter spout 35 mm
- rosette Ø 55 mm
- 2x screw-in M 10 x 1 pressure hose, leak-tested
- max. flow 7 l/min
- lead-free
- WRAS 2212026
- This product can help a building meet the requirements of Green Building Rating Systems, e.g. LEED®, BREEAM®, DGNB

Only suitable for basins with an overflow.

	Chrome	20 710 892-00
	Brushed Platinum	20 710 892-06
	Platinum	20 710 892-08
	Dark Chrome	20 710 892-19
	Brushed Durabronss (23kt Gold)	20 710 892-28
	Matte Black	20 710 892-33
	Brushed Bronze	20 710 892-42
	Brushed Champagne (22kt Gold)	20 710 892-46
	Champagne (22kt Gold)	20 710 892-47
	Brushed Chrome	20 710 892-93
	Brushed Dark Platinum	20 710 892-99

Recommended miscellaneous



- High pressure hoses -**
- 2x 3/8" x 1/2" x 500mm high pressure hose

12 506 970 90

20 710 892

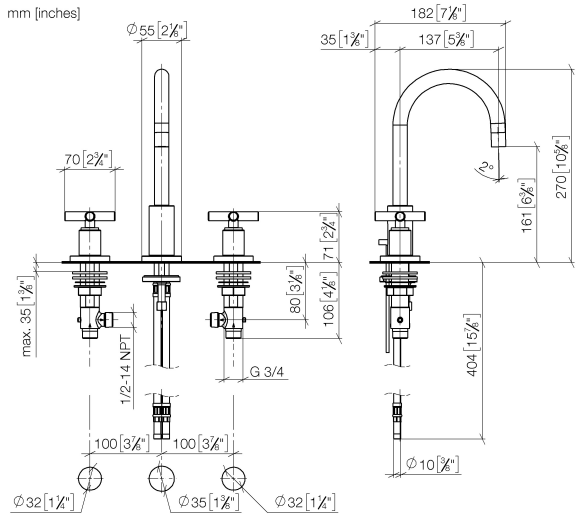

Flow rate chart

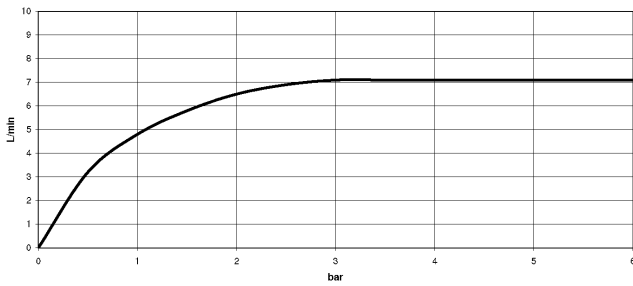

Codes & Standards

DIN 4109

EN 200

Executive Order
no. 1007

ISO 3822

Scottish Water
Byelaws

UK Water Supply
Regulations

Ü-Zeichen

VA-Zeichen

XP P 41-280



TARA Three-hole basin mixer with pop-up waste - Chrome

TARA

20 710 892

Certificates

LGA_18

ACS_20 ACC LY

ETA_18

WRAS_2212

GDV_0400

20 710 892

Product version from 6/30/2009 to 6/25/2021

Product version from 6/25/2021

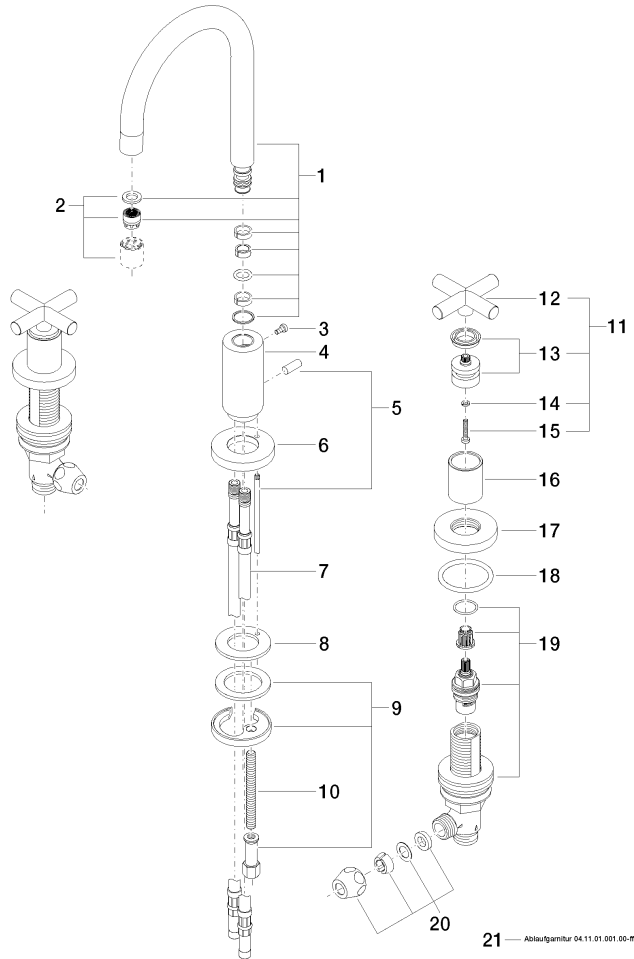



TARA Three-hole basin mixer with pop-up waste - Chrome

TARA

20 710 892

Spare parts list

Product version from 6/30/2009 to 6/25/2021

Product version from 6/25/2021

No.	Item Number	Name	Quantity used	Delivery time
	90 28 22 217 01-00	spout	32	10