



























28 016 979 Product version from 4/1/2024



- Three or five settings: COMPACT RAIN, COMPACT SOFT FLOW, COMPACT AQUAPRESSURE FLOW, max. flow rate 15 l/min (at 3 bar)
- with anti-scale system
- spray head Ø 130 mm
- 1/2" connection
- WRAS

Intrinsic protection against back flow.

Fits: IMO, LULU, MADISON, MEM, TARA, CL.1, LISSÉ, VAIA, META, CYO

	Chrome	28 016 979-00
	Chrome	28 016 979-00 0010
	Brushed Platinum	28 016 979-06 0010
	Brushed Platinum	28 016 979-06
	Platinum	28 016 979-08 0010
	Platinum	28 016 979-08
	Dark Chrome	28 016 979-19
	Dark Chrome	28 016 979-19 0010
	Light Gold	28 016 979-26
	Light Gold	28 016 979-26 0010
	Brushed Light Gold	28 016 979-27
	Brushed Light Gold	28 016 979-27 0010
	Brushed Durabrass (23kt Gold)	28 016 979-28
	Brushed Durabrass (23kt Gold)	28 016 979-28 0010
	Matte Black	28 016 979-33
	Matte Black	28 016 979-33 0010
	Brushed Bronze	28 016 979-42 0010
	Brushed Bronze	28 016 979-42
	Brushed Champagne (22kt Gold)	28 016 979-46
	Brushed Champagne (22kt Gold)	28 016 979-46 0010
	Champagne (22kt Gold)	28 016 979-47
	Champagne (22kt Gold)	28 016 979-47 0010
	Brushed Chrome	28 016 979-93
	Brushed Chrome	28 016 979-93 0010
	Brushed Dark Platinum	28 016 979-99
	Brushed Dark Platinum	28 016 979-99 0010



Hand shower - Chrome

IMO

28 016 979 Product version from 4/1/2024

28 016 979 Product version from 4/1/2024

mm [inches]

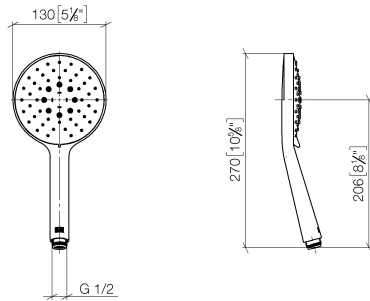

Flow rate chart

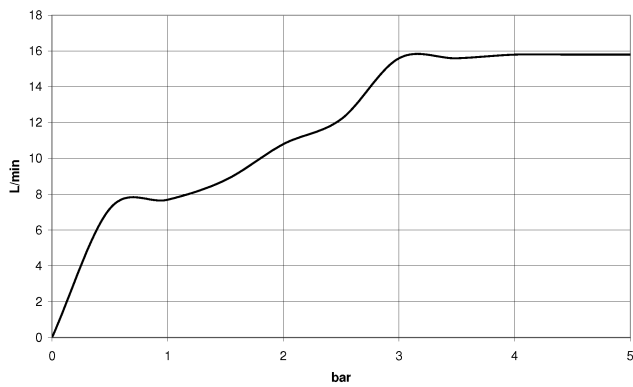

Codes & Standards

DIN 4109

EN 1112

ISO 3822

Scottish Water
Byelaws

UK Water Supply
Regulations

Ü-Zeichen



Hand shower - Chrome

IMO

28 016 979 Product version from 4/1/2024

Certificates

DVGW_DW-
6517DN0

LGA_29

WRAS_2009

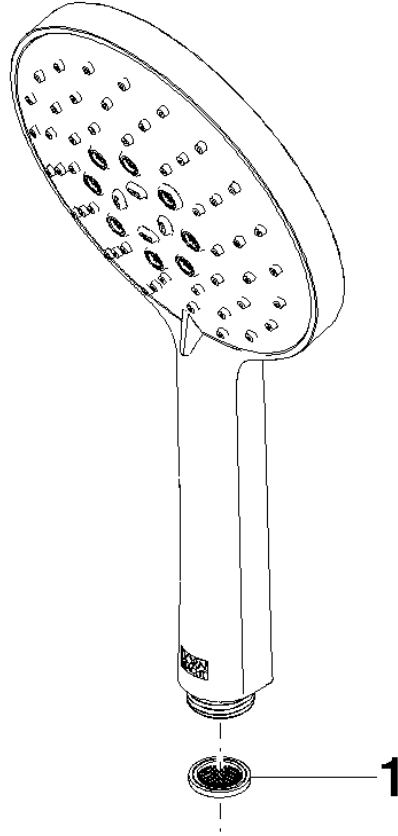

Spare parts list

No.	Item Number	Name	Quantity used	Delivery time
1	09 23 01 039 90	sieve	1	2