

Rain shower with wall fixing 300 mm - Chrome







IMO

28 679 670



- 450mm projection
- rain shower Ø 300 mm
- PURE RAIN, max. flow rate 14 l/min (at 3 bar)
- Function from: 10 l/min
- rosette 65 x 65 mm
- 1/2" connection
- with anti-scale system
- quick clearing
- WRAS 2212012

Fits: IMO, CYO

	Chrome	28 679 670-00
	Brushed Platinum	28 679 670-06
	Platinum	28 679 670-08
	Brushed Durabronz (23kt Gold)	28 679 670-28
	Matte Black	28 679 670-33
	Brushed Chrome	28 679 670-93
	Brushed Dark Platinum	28 679 670-99

Recommended miscellaneous



- Concealed wall elbow -** 35 085 970 90
- max. recess depth 163 mm
 - min. recess depth 90 mm

Rain shower with wall fixing 300 mm - Chrome

28 679 670

mm [inches]

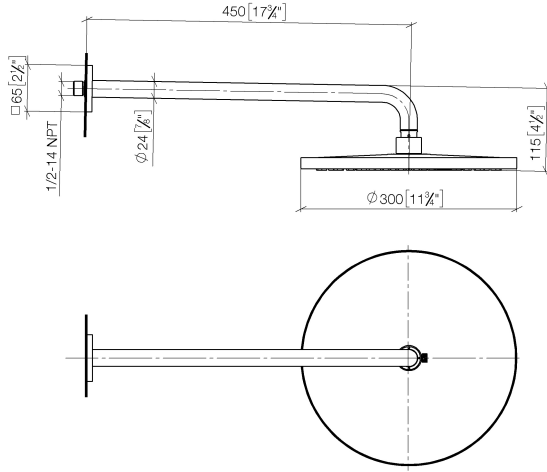

Flow rate chart



Codes & Standards

DIN 4109

ISO 3822

Scottish Water
Byelaws

UK Water Supply
Regulations

Ü-Zeichen



Rain shower with wall fixing 300 mm - Chrome

IMO

28 679 670

Certificates

LGA_29

WRAS_2212

28 679 670

Product version from 3/13/2017

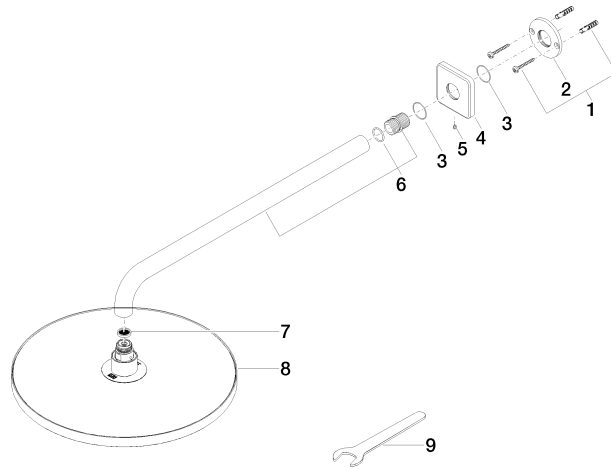



Rain shower with wall fixing 300 mm - Chrome

IMO

28 679 670

Spare parts list

Product version from 3/13/2017

No.	Item Number	Name	Quantity used	Delivery time
	04 30 31 032 00 90	fixing set	10	2