















33 501 662



- 125mm projection
- fixed spout
- circular, air-enriched flow
- height of mixer 134 mm
- height up to aerator 52 mm
- hole diameter 35 mm
- 2x screw-in M 8 x 1 pressure hose, leak-tested
- max. flow 5.7 l/min
- lead-free
- This product can help a building meet the requirements of Green Building Rating Systems, e.g. LEED®, BREEAM®, DGNB
- WRAS 2003051

Only suitable for basins with an overflow.

	Matte Black	33 501 662-33
	Chrome	33 501 662-00
	Brushed Platinum	33 501 662-06
	Platinum	33 501 662-08
	Dark Chrome	33 501 662-19
	Light Gold	33 501 662-26
	Brushed Light Gold	33 501 662-27
	Brushed Durabronze (23kt Gold)	33 501 662-28
	Red	33 501 662-29
	Orange	33 501 662-30
	Dark Green	33 501 662-31
	Brushed Bronze	33 501 662-42
	Brushed Champagne (22kt Gold)	33 501 662-46
	Champagne (22kt Gold)	33 501 662-47
	Brushed Chrome	33 501 662-93
	Brushed Dark Platinum	33 501 662-99

33 501 662

mm [inches]

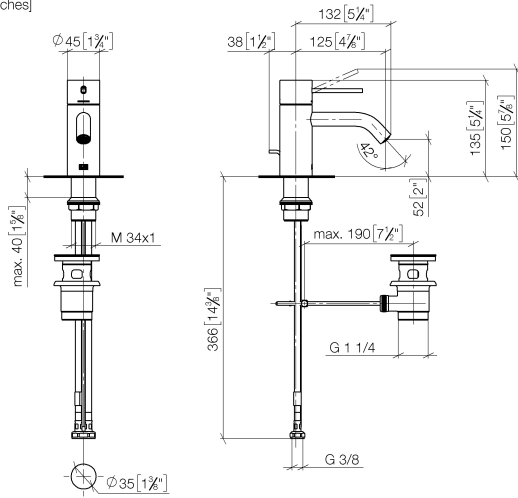

**Flow rate chart**



**Codes & Standards**

DIN 4109

ISO 3822

Scottish Water  
Byelaws

UK Water Supply  
Regulations

**Ü-Zeichen**



**META META SLIM Single-lever basin mixer with pop-up waste - Matte Black**

---

META

33 501 662

Certificates

---

LGA\_29

WRAS\_2003

33 501 662

Product version up to 1/23/2020

Product version from 1/23/2020

**Product version from 10/1/2021**

Parts for other  
finishes can be found  
here: [Chrome](#)

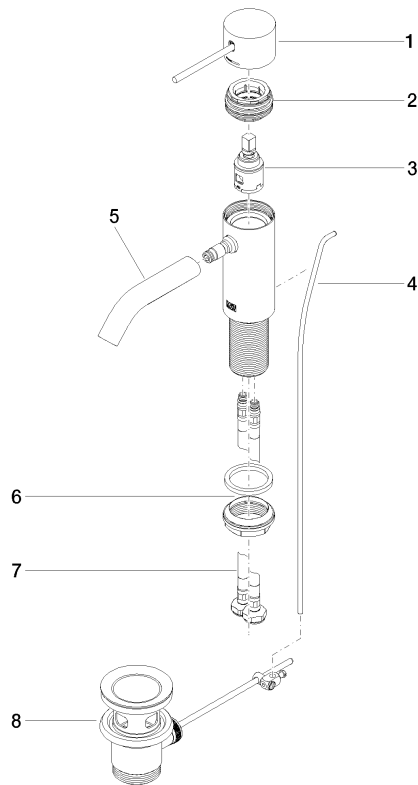



**META META SLIM Single-lever basin mixer with pop-up waste - Matte Black**

META

33 501 662

**Spare parts list**

Product version up to 1/23/2020

Product version from 1/23/2020

**Product version from 10/1/2021**

No.	Item Number	Name	Quantity used	Delivery time
	90 20 66 020 00-33	handle	9	30