

33 513 882



- 166mm projection
- pivotable spout 360°
- circular, air-enriched flow
- height of mixer 310 mm
- height up to aerator 188 mm
- hole diameter 35 mm
- 2x screw-in M 8 x 1 pressure hose, leak-tested
- max. flow 5.7 l/min
- lead-free
- This product can help a building meet the requirements of Green Building Rating Systems, e.g. LEED®, BREEAM®, DGNB
- WRAS 2212025

Only suitable for basins with an overflow.

	Brushed Dark Platinum	33 513 882-99
	Chrome	33 513 882-00
	Brushed Platinum	33 513 882-06
	Platinum	33 513 882-08
	Dark Chrome	33 513 882-19
	Brushed Durabronze (23kt Gold)	33 513 882-28
	Matte Black	33 513 882-33
	Brushed Bronze	33 513 882-42
	Brushed Champagne (22kt Gold)	33 513 882-46
	Champagne (22kt Gold)	33 513 882-47
	Brushed Chrome	33 513 882-93

33 513 882

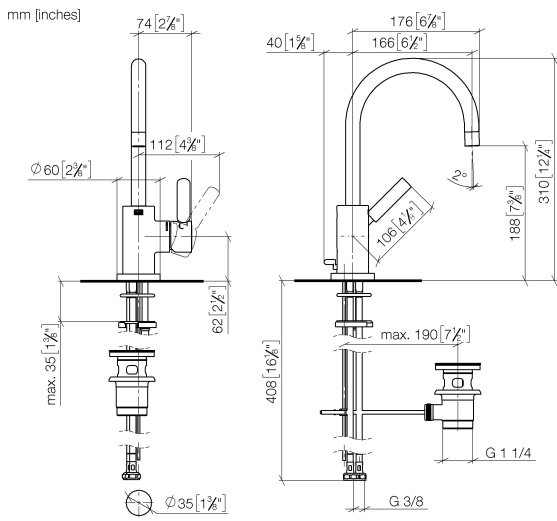

**Flow rate chart**



**Codes & Standards**

DIN 4109

ISO 3822

Scottish Water  
Byelaws

UK Water Supply  
Regulations

**Ü-Zeichen**



TARA Single-lever basin mixer with pop-up waste - Brushed Dark Platinum

---

TARA

33 513 882

Certificates

---

LGA\_38

WRAS\_2212

33 513 882

**Product version from 4/1/2024**

Parts for other finishes can be found here: [Chrome](#)

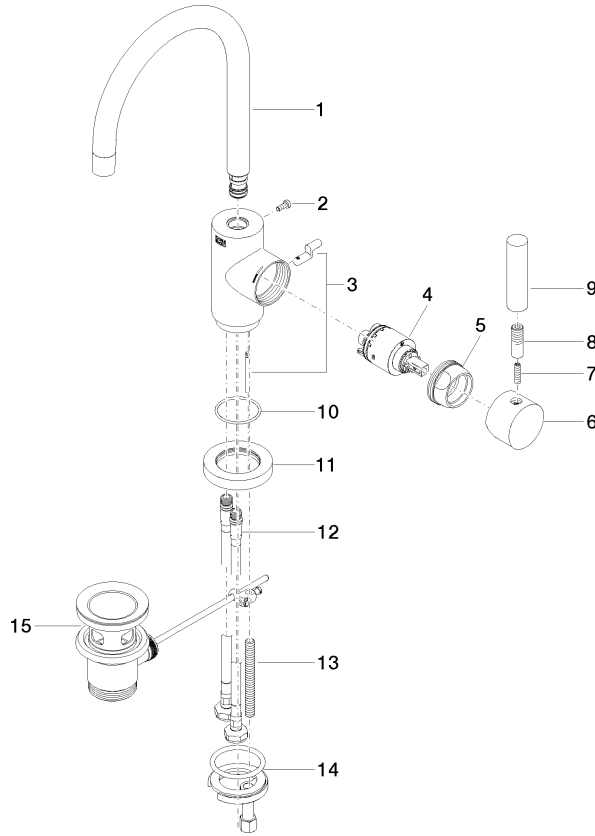



TARA Single-lever basin mixer with pop-up waste - Brushed Dark Platinum

TARA

33 513 882

**Spare parts list**

**Product version from 4/1/2024**

No.	Item Number	Name	Quantity used	Delivery time
	90 28 22 372 00-99	spout	16	30