





CYO Wall-mounted single-lever basin mixer without pop-up waste - Brushed Dark Platinum

36 861 811



- 190mm projection
- fixed spout
- rectangular, air-enriched flow
- hole diameter spout 37 mm
- hole diameter single-lever mixer 57 mm
- rosette for mixer 80 x 80mm
- max. flow 4.5 l/min
- lead-free
- This product can help a building meet the requirements of Green Building Rating Systems, e.g. LEED®, BREEAM®, DGNB
- WRAS

	Brushed Dark Platinum	36 861 811-99
	Chrome	36 861 811-00
	Brushed Platinum	36 861 811-06
	Dark Chrome	36 861 811-19
	Brushed Durabronze (23kt Gold)	36 861 811-28

Required miscellaneous



Concealed wall-mounted single-lever mixer - 35 860 970 90

- max. recess depth mm
- min. recess depth mm
- mixer can be placed above, to the left or to the right of the spout.



CYO Wall-mounted single-lever basin mixer without pop-up waste - Brushed Dark Platinum

36 861 811
mm [inches]

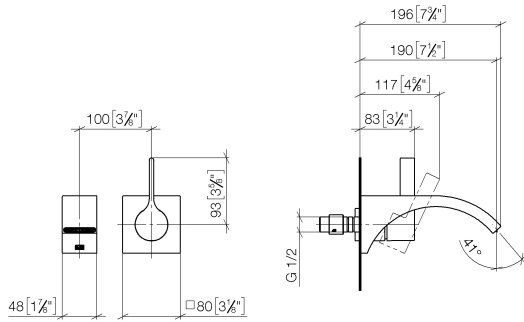

Flow rate chart

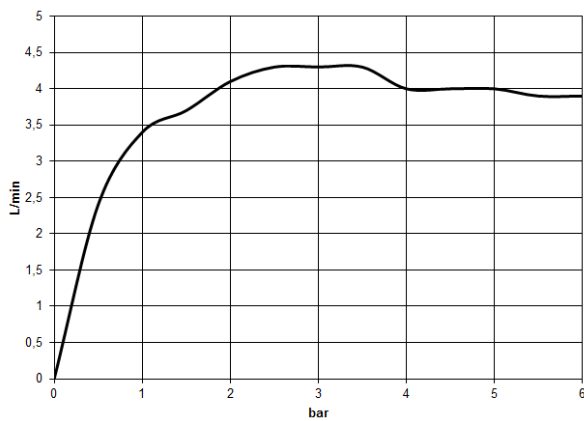

Codes & Standards

ASME A112.18.1	cUPC	DIN 4109	EPA WaterSense
ISO 3822	NSF372	NSF61	Scottish Water Byelaws
UK Water Supply Regulations	Ü-Zeichen	WaterSense	





CYO Wall-mounted single-lever basin mixer without pop-up waste - Brushed
Dark Platinum

36 861 811

Certificates

IAPMO_N-4976

WRAS_2107

IAPMO_6397

LGA_38

IAPMO_8834

IAPMO_4976 (

CYO Wall-mounted single-lever basin mixer without pop-up waste - Brushed Dark Platinum

36 861 811

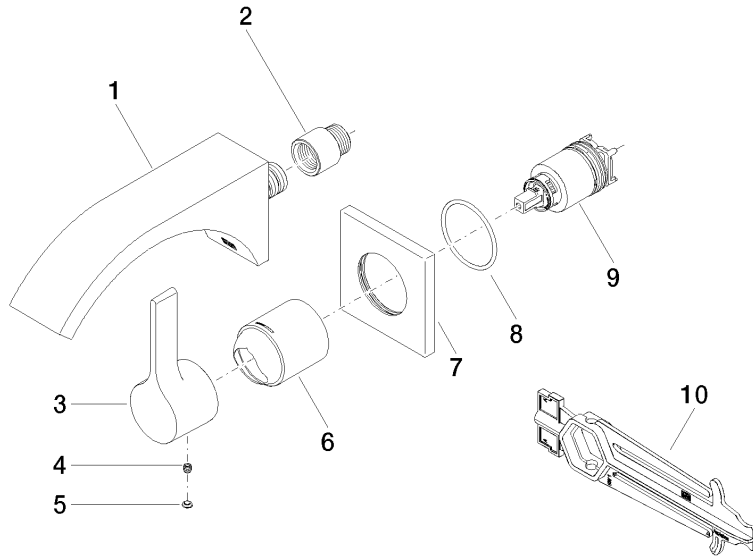

Spare parts list

No.	Item Number	Name	Quantity used	Delivery time
1	13 805 811-99	CYO Wall-mounted basin spout without pop-up waste - Brushed Dark Platinum	1	20
2	09 24 03 072 10 90	nipple	1	2
3	09 20 80 021-99	handle	1	20
4	90 31 11 030 00 90	pin	1	2
5	90 31 20 087 00-99	plug	1	20
6	09 11 02 288-99	cover	1	20
7	09 27 78 039-99	rosette	1	20
8	90 14 10 049 00 90	seal	1	2
9	90 15 05 064 01 90	cartridge	1	2
10	90 30 09 064 00 90	key	1	2