





IMO Tissue holder without cover - Chrome

83 500 670 Product version from 4/1/2024



- width 166mm
- height 60 mm
- 73mm projection

	Chrome	83 500 670-00
	Brushed Platinum	83 500 670-06
	Dark Chrome	83 500 670-19
	Matte Black	83 500 670-33
	Brushed Chrome	83 500 670-93

IMO Tissue holder without cover - Chrome

83 500 670 Product version from 4/1/2024

mm [inches]

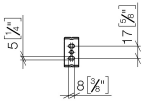
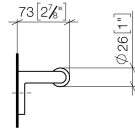
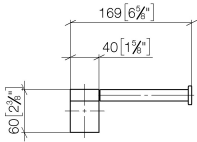

IMO Tissue holder without cover - Chrome

83 500 670 Product version from 4/1/2024

Parts for other
finishes can be found
here: Brushed
Platinum

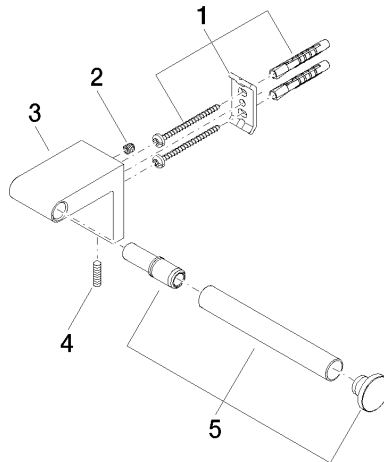

Spare parts list

No.	Item Number	Name	Quantity used	Delivery time
1	05 17 20 736 00 90	fixing set	1	2
2	09 31 11 049 90	pin	1	2
3	08 17 67 502-00	holder	1	10
4	04 31 11 113 00 90	pin	1	2
5	90 28 22 650 00-00	holder	1	10