







CL.1 Deck-mounted basin spout without pop-up waste - Brushed Platinum

CL.1

13 715 705



- 160mm projection
- fixed spout
- rectangular spray pattern with 40 individual jets
- height of mixer 204 mm
- height up to aerator 190 mm
- hole diameter 35 mm
- 2x screw-in M 10 x 1 pressure hose, leak-tested
- 1/2" connection
- max. flow 4 l/min
- lead-free
- This product can help a building meet the requirements of Green Building Rating Systems, e.g. LEED®, BREEAM®, DGNB
- WRAS 1512011

	Brushed Platinum	13 715 705-06
	Chrome	13 715 705-00
	Dark Chrome	13 715 705-19
	Brushed Champagne (22kt Gold)	13 715 705-46
	Champagne (22kt Gold)	13 715 705-47
	Brushed Dark Platinum	13 715 705-99

13 715 705

mm [inches]

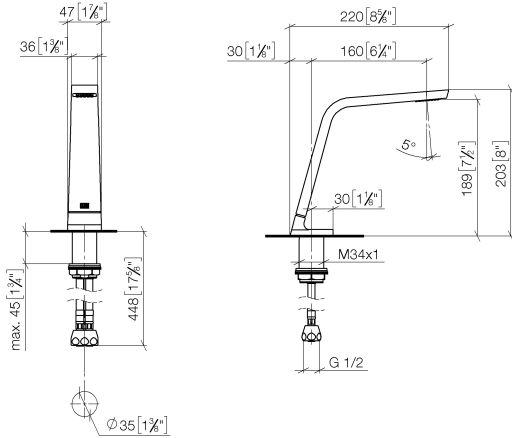

Flow rate chart

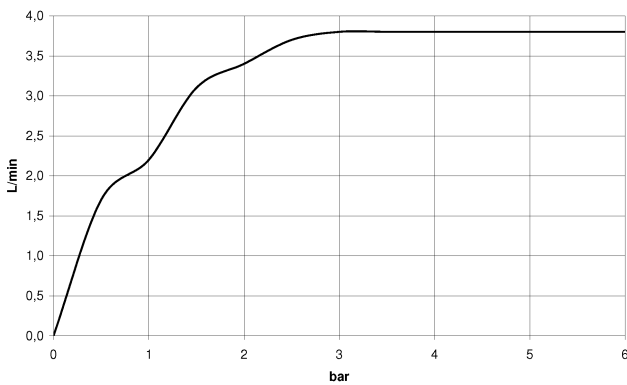

Codes & Standards

ASME A112.18.1	cUPC	DIN 4109	EPA WaterSense
Executive Order no. 1007	ISO 3822	NSF372	NSF61
Scottish Water Byelaws	UK Water Supply Regulations	Ü-Zeichen	WaterSense 



CL.1 Deck-mounted basin spout without pop-up waste - Brushed Platinum

CL.1

13 715 705

Certificates

LGA_28

GDV_0400

IAPMO_N-4

IAPMO_8834

IAPMO_6

IAPMO_4976

WRAS_1512

13 715 705

Product version from 3/9/2015 to 6/15/2021

Product version from 7/1/2021

Parts for other finishes can be found here: [Chrome](#)

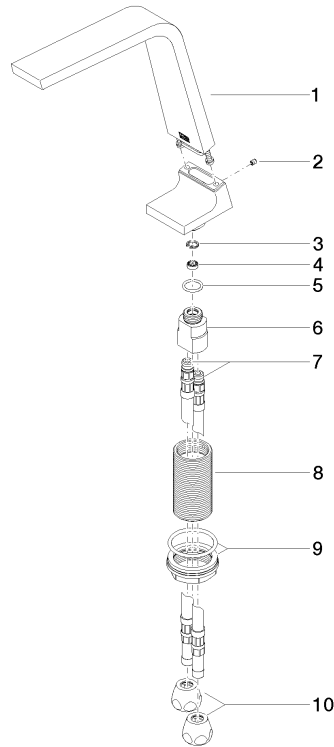



CL.1 Deck-mounted basin spout without pop-up waste - Brushed Platinum

CL.1

13 715 705

Spare parts list

Product version from 3/9/2015 to 6/15/2021

Product version from 7/1/2021

No.	Item Number	Name	Quantity used	Delivery time
	90 11 70 003 00-06	spout	12	10