

17 861 875







- 146mm projection
- rigid, thermally insulated spout
- laminar flow
- height of mixer 288 mm
- height up to laminar flow regulator 180 mm
- hole diameter 35 mm
- provides filtered, hot water up to 93°C
- provides filtered, cold water
- max. flow 2 l/min at 3 bar flow pressure
- ready-to-use control unit for wall mounting (137mm x 159mm x 60mm)
- electronic magnetic valve
- 100-230 V, 50-60 Hz, 18 W power supply unit, incl. country-specific adapter set
- lead-free
- Spout ring cannot be removed.
- This product can help a building meet the requirements of Green Building Rating Systems, e.g. LEED®, BREEAM®, DGNB

A minimum flow pressure of 3 bar is necessary for the HOT & COLD WATER DISPENSER to work perfectly in conjunction with a hot water tank and filter.

In addition, the installation must be above a kitchen sink.

The filter cartridge must be changed every six months. The installation instructions contain further information for guidance.

Detailed planning information and technical data can be found at [www.dornbracht.com/professional](http://www.dornbracht.com/professional)

	Brushed Champagne (22kt Gold)	17 861 875-46
	Chrome	17 861 875-00
	Brushed Platinum	17 861 875-06
	Platinum	17 861 875-08
	Durabrand (23kt Gold)	17 861 875-09
	Dark Chrome	17 861 875-19
	Brushed Durabrand (23kt Gold)	17 861 875-28
	Matte Black	17 861 875-33
	Champagne (22kt Gold)	17 861 875-47
	Brushed Chrome	17 861 875-93
	Brushed Dark Platinum	17 861 875-99



# TARA ULTRA HOT & COLD WATER DISPENSER - Brushed Champagne (22kt Gold)

TARA ULTRA

17 861 875

mm [inches]

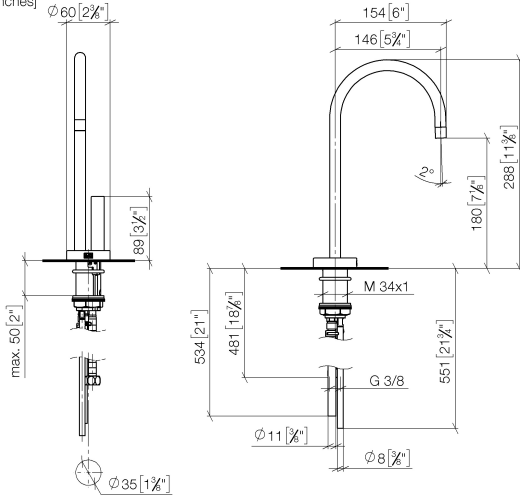

## Flow rate chart

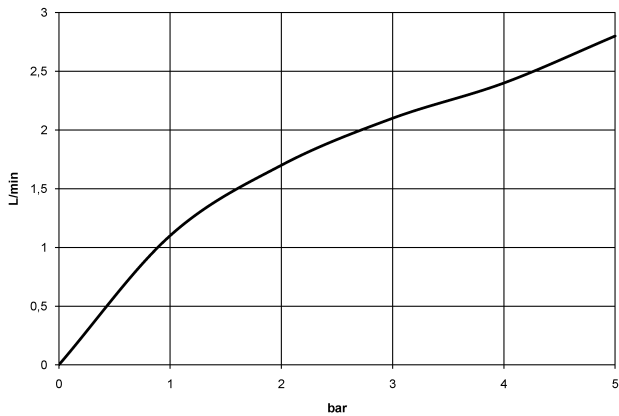

## Codes & Standards

Executive Order  
no. 1007

NSF372

NSF61



TARA ULTRA HOT & COLD WATER DISPENSER - Brushed Champagne  
(22kt Gold)

TARA ULTRA

---

17 861 875  
Certificates

---

GDV\_0400

IAPMO\_N-4

IAPMO\_6



# TARA ULTRA HOT & COLD WATER DISPENSER - Brushed Champagne (22kt Gold)

TARA ULTRA

17 861 875

**Product version from 5/28/2022**

Parts for other finishes can be found here: [Chrome](#)

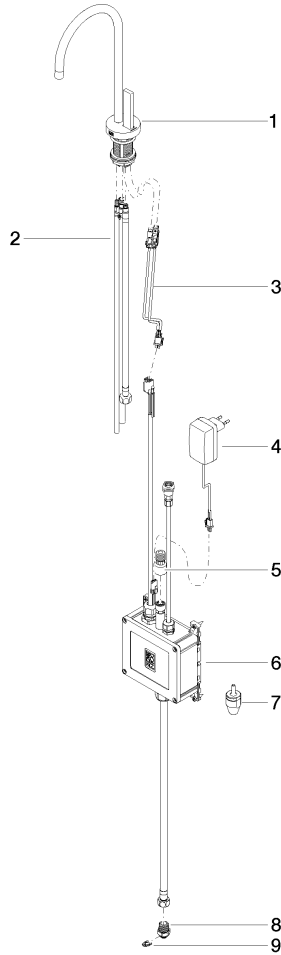



TARA ULTRA HOT & COLD WATER DISPENSER - Brushed Champagne  
(22kt Gold)

TARA ULTRA

---

17 861 875

## **Spare parts list**

**Product version from 5/28/2022**