





26 413 892



- slide bar
- Pipe diameter 18 mm
- rosettes Ø 55 mm
- gauge 800 mm
- metal shower hose 1750mm with integrated anti-twist protection
- shower hose connector 3/8"
- WRAS 2009048

This article does not include a hand shower!

| | | |
|--|-------------------------------------|---------------|
|  | Chrome | 26 413 892-00 |
|  | Brushed Platinum | 26 413 892-06 |
|  | Platinum | 26 413 892-08 |
|  | Dark Chrome | 26 413 892-19 |
|  | Brushed Durabronze (23kt Gold) | 26 413 892-28 |
|  | Matte Black | 26 413 892-33 |
|  | Brushed Champagne (22kt Gold) | 26 413 892-46 |
|  | Champagne (22kt Gold) | 26 413 892-47 |
|  | Brushed Chrome | 26 413 892-93 |
|  | Brushed Dark Platinum | 26 413 892-99 |

26 413 892

Recommended miscellaneous

| | | |
|---|--|---------------|
|  | Concealed wall elbow - •min. recess depth 90 mm •max. recess depth 163 mm | 35 085 970 90 |
|---|--|---------------|

Required miscellaneous

| | | |
|---|--|-----------------------|
|  | Hand shower FlowReduce - Chrome | 28 016 979-00 0010 |
|---|--|-----------------------|

Required miscellaneous

| | | |
|---|-----------------------------|---------------|
|  | Hand shower - Chrome | 28 017 979-00 |
|---|-----------------------------|---------------|

Required miscellaneous

| | | |
|---|-----------------------------|---------------|
|  | Hand shower - Chrome | 28 012 979-00 |
|---|-----------------------------|---------------|

Required miscellaneous

| | | |
|---|--|-----------------------|
|  | Hand shower FlowReduce - Chrome | 28 018 979-00 0010 |
|---|--|-----------------------|

Required miscellaneous

| | | |
|---|--|-----------------------|
|  | SERIES-VARIOUS Hand shower - Chrome | 28 029 979-00 0010 |
|---|--|-----------------------|

Required miscellaneous

| | | |
|---|--|-----------------------|
|  | SERIES-VARIOUS Hand shower - Chrome | 28 025 979-00 0010 |
|---|--|-----------------------|

Recommended miscellaneous

| | | |
|---|----------------------------|---------------|
|  | Wall elbow - Chrome | 28 450 625-00 |
|---|----------------------------|---------------|

Required miscellaneous

| | | |
|---|-----------------------------|---------------|
|  | Hand shower - Chrome | 28 016 979-00 |
|---|-----------------------------|---------------|

Required miscellaneous

| | | |
|---|--|-----------------------|
|  | Hand shower FlowReduce - Chrome | 28 012 979-00 0010 |
|---|--|-----------------------|

Required miscellaneous

| | | |
|---|-----------------------------|---------------|
|  | Hand shower - Chrome | 28 018 979-00 |
|---|-----------------------------|---------------|

Required miscellaneous

| | | |
|---|--|-----------------------|
|  | SERIES-VARIOUS Hand shower - Chrome | 28 027 979-00 0010 |
|---|--|-----------------------|

Required miscellaneous

| | | |
|---|--|---------------|
|  | SERIES-VARIOUS Hand shower - Chrome | 28 029 979-00 |
|---|--|---------------|

26 413 892

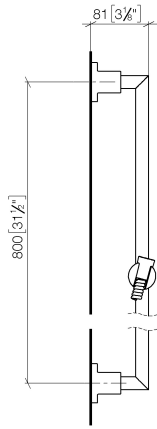
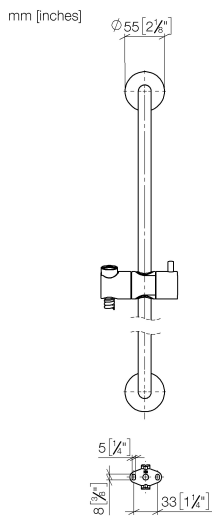

Certificates

WRAS_2009048. ACS_20 ACC LY 738. IAPMO_4976 (1).

26 413 892

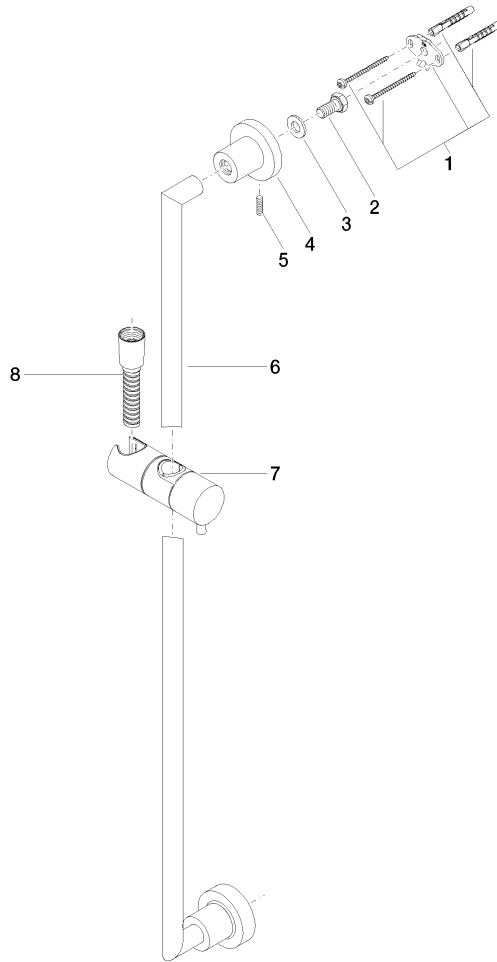

Spare parts list

| No. | Item Number | Name | Quantity used | Delivery time |
|-----|--------------------|--|---------------|---------------|
| 1 | 05 17 20 739 00 90 | fixing set | 2 | 2 |
| 2 | 09 30 30 071 90 | screw | 2 | 2 |
| 3 | 09 30 11 046 90 | disc | 2 | 2 |
| 4 | 08 17 89 505-00 | holder | 2 | 10 |
| 5 | 04 31 11 113 00 90 | pin | 2 | 2 |
| 6 | 05 28 22 590 00-00 | bar | 1 | 10 |
| 7 | 12 580 970-00 | Slide unit - Chrome | 1 | 10 |
| 8 | 28 322 970-00 | Metal shower hose 1/2" x 3/8" x 1750 mm - Chrome | 1 | 2 |