

















META Single-lever basin mixer without pop-up waste - Brushed Champagne (22kt Gold)

META

33 525 660



- 105mm projection
- fixed spout
- circular, air-enriched flow
- height of mixer 138 mm
- height up to aerator 57 mm
- hole diameter 35 mm
- rosette Ø 50 mm optional
- 2x screw-in M 8 x 1 pressure hose, leak-tested
- max. flow 5.7 l/min
- lead-free
- This product can help a building meet the requirements of Green Building Rating Systems, e.g. LEED®, BREEAM®, DGNB
- WRAS 2003058

	Brushed Champagne (22kt Gold)	33 525 660-46
	Chrome	33 525 660-00
	Brushed Platinum	33 525 660-06
	Platinum	33 525 660-08
	Dark Chrome	33 525 660-19
	Light Gold	33 525 660-26
	Brushed Light Gold	33 525 660-27
	Brushed Durabronze (23kt Gold)	33 525 660-28
	Red	33 525 660-29
	Orange	33 525 660-30
	Dark Green	33 525 660-31
	Matte Black	33 525 660-33
	Brushed Bronze	33 525 660-42
	Champagne (22kt Gold)	33 525 660-47
	Brushed Chrome	33 525 660-93
	Brushed Dark Platinum	33 525 660-99

**META Single-lever basin mixer without pop-up waste - Brushed Champagne
(22kt Gold)**

META

33 525 660
mm [inches]

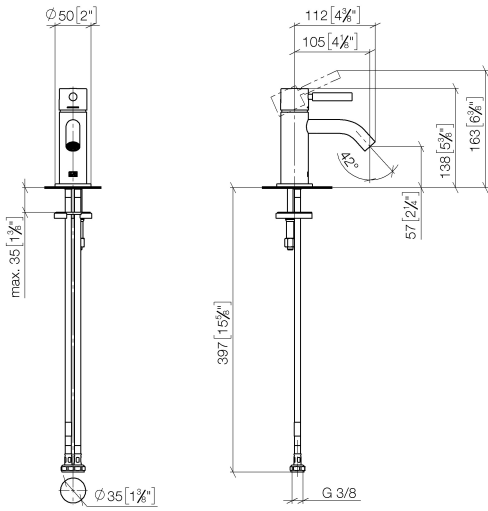

Flow rate chart

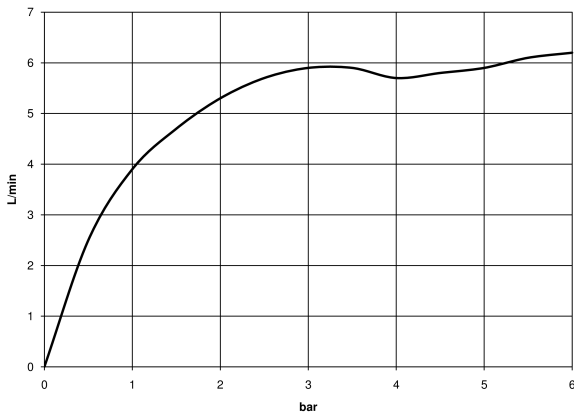

33 525 660

Product version from 1/23/2020

Parts for other
finishes can be found
here: [Chrome](#)

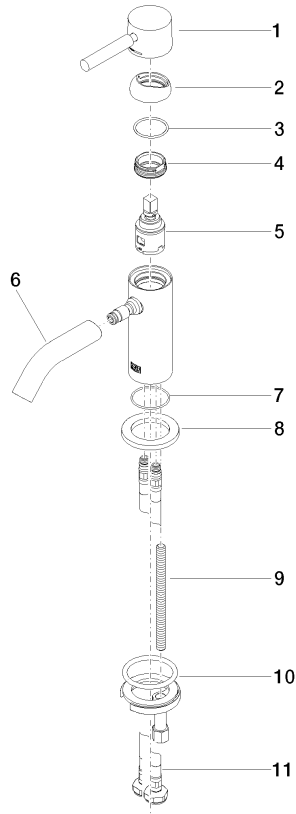



META Single-lever basin mixer without pop-up waste - Brushed Champagne
(22kt Gold)

META

33 525 660

Spare parts list

Product version from 1/23/2020