

















33 525 660



- 105mm projection
- fixed spout
- circular, air-enriched flow
- height of mixer 138 mm
- height up to aerator 57 mm
- hole diameter 35 mm
- rosette Ø 50 mm optional
- 2x screw-in M 8 x 1 pressure hose, leak-tested
- max. flow 5.7 l/min
- lead-free
- This product can help a building meet the requirements of Green Building Rating Systems, e.g. LEED®, BREEAM®, DGNB
- WRAS 2003058

| | | |
|--|--------------------------------|---------------|
|  | Brushed Chrome | 33 525 660-93 |
|  | Chrome | 33 525 660-00 |
|  | Brushed Platinum | 33 525 660-06 |
|  | Platinum | 33 525 660-08 |
|  | Dark Chrome | 33 525 660-19 |
|  | Light Gold | 33 525 660-26 |
|  | Brushed Light Gold | 33 525 660-27 |
|  | Brushed Durabronze (23kt Gold) | 33 525 660-28 |
|  | Red | 33 525 660-29 |
|  | Orange | 33 525 660-30 |
|  | Dark Green | 33 525 660-31 |
|  | Matte Black | 33 525 660-33 |
|  | Brushed Bronze | 33 525 660-42 |
|  | Brushed Champagne (22kt Gold) | 33 525 660-46 |
|  | Champagne (22kt Gold) | 33 525 660-47 |
|  | Brushed Dark Platinum | 33 525 660-99 |

33 525 660

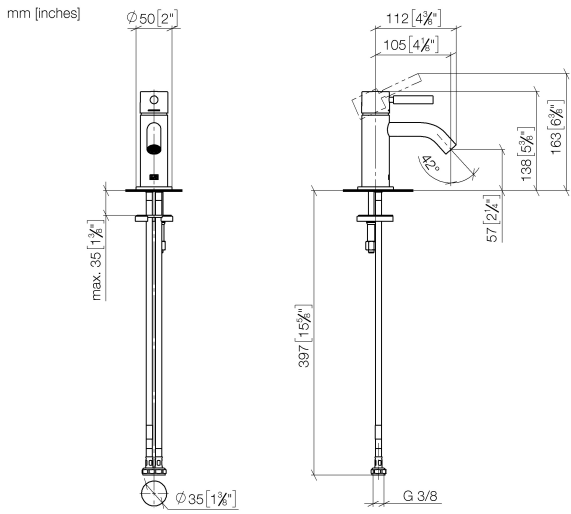

Flow rate chart



Codes & Standards

DIN 4109

EN 817

ISO 3822

Scottish Water
Byelaws

UK Water Supply
Regulations

Ü-Zeichen



META Single-lever basin mixer without pop-up waste - Brushed Chrome

META

33 525 660

Certificates

WRAS_2003

LGA_29

DVGW_DW-
6506DNO

33 525 660

Product version up to 1/23/2020

Product version from 1/23/2020

Parts for other
finishes can be found
here: [Chrome](#)

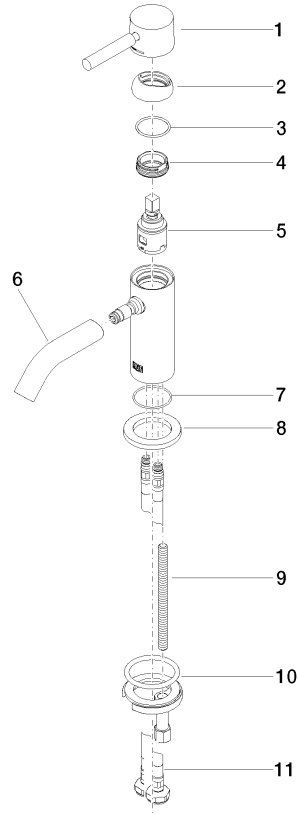



META Single-lever basin mixer without pop-up waste - Brushed Chrome

META

33 525 660

Spare parts list

Product version up to 1/23/2020

Product version from 1/23/2020

| No. | Item Number | Name | Quantity used | Delivery time |
|-----|--------------------|--------|---------------|---------------|
| | 90 20 66 009 00-93 | handle | 12 | 20 |