







IMO Single-lever basin mixer with high spout without pop-up waste - Dark Chrome

IMO

33 526 671 Product version from 4/1/2024



- 165mm projection
- fixed spout
- rectangular, air-enriched flow
- height of mixer 278 mm
- height up to aerator 235 mm
- hole diameter 35 mm
- 2x screw-in M 8 x 1 pressure hose, leak-tested
- max. flow 4.6 l/min
- lead-free
- This product can help a building meet the requirements of Green Building Rating Systems, e.g. LEED®, BREEAM®, DGNB

	Dark Chrome	33 526 671-19
	Chrome	33 526 671-00
	Brushed Platinum	33 526 671-06
	Brushed Light Gold	33 526 671-27
	Matte Black	33 526 671-33
	Brushed Chrome	33 526 671-93
	Brushed Dark Platinum	33 526 671-99

33 526 671 Product version from 4/1/2024

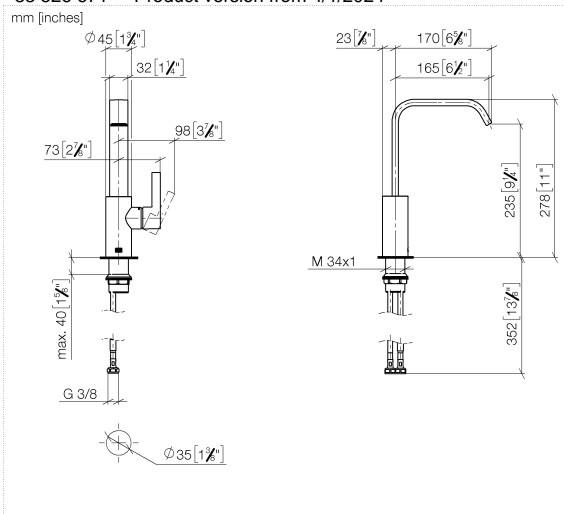

Flow rate chart



Codes & Standards

DIN 4109

ISO 3822

Ü-Zeichen



IMO Single-lever basin mixer with high spout without pop-up waste - Dark Chrome

IMO

33 526 671 Product version from 4/1/2024

Certificates

LGA_28

IMO Single-lever basin mixer with high spout without pop-up waste - Dark Chrome

IMO

33 526 671 Product version from 4/1/2024

Parts for other finishes can be found here: [Chrome](#)

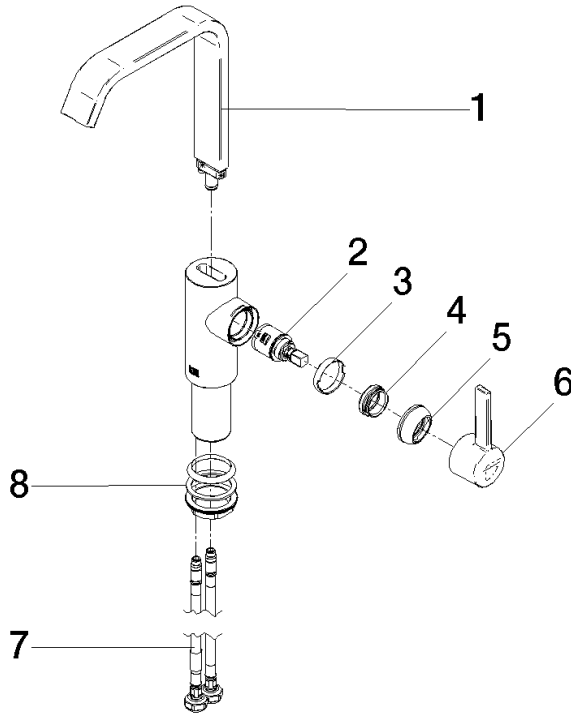

Spare parts list

No.	Item Number	Name	Quantity used	Delivery time
1	90 28 22 404 00-19	spout	1	-
Spare part can no longer be ordered, please order the replacement item				
2	90 15 05 042 00 90	cartridge	1	2
3	90 23 10 128 00 90	nut	1	2
4	09 24 04 266 90	nut	1	2
5	90 28 30 061 00-19	cover	1	-
Spare part can no longer be ordered, please order the replacement item				
6	90 20 67 027 00-19	handle	1	20
7	04 30 04 100 00 90	hose	2	2
8	04 23 10 044 07 90	fixing set	1	2