







33 805 861



- 166mm projection
- pivotable spout 360°
- Optional swivel limiter available with swivel limiter set 12 820 970 90
- air-enriched flow
- max. flow 8 l/min at 3 bar flow pressure
- lead-free
- This product can help a building meet the requirements of Green Building Rating Systems, e.g. LEED®, BREEAM®, DGNB

	Chrome	33 805 861-00
	Brushed Platinum	33 805 861-06
	Platinum	33 805 861-08
	Durabrass (23kt Gold)	33 805 861-09
	Dark Chrome	33 805 861-19
	Brushed Durabrass (23kt Gold)	33 805 861-28
	Matte Black	33 805 861-33
	Brushed Champagne (22kt Gold)	33 805 861-46
	Champagne (22kt Gold)	33 805 861-47
	Brushed Chrome	33 805 861-93
	Brushed Dark Platinum	33 805 861-99

Recommended miscellaneous

Swivel limitation set - 12 820 970 90



Recommended miscellaneous

Strainer waste with control handle - Chrome 10 712 970-00



Recommended miscellaneous

Dispenser without rosette - Chrome 82 424 970-00



33 805 861

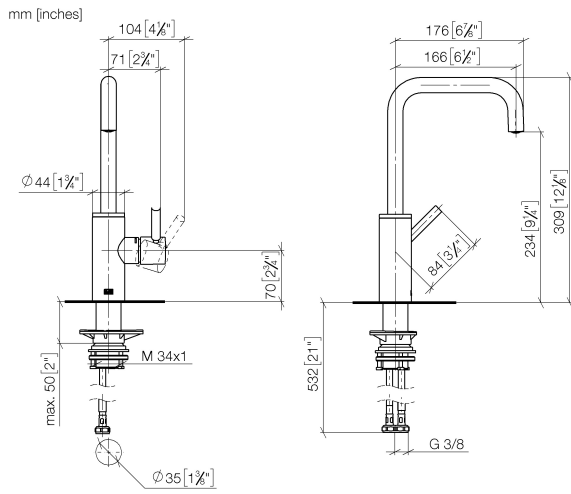

Flow rate chart

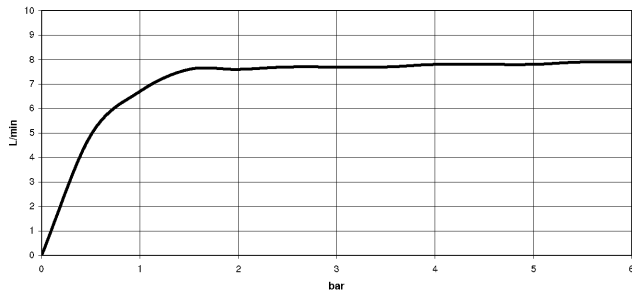

Certificates

LGA_38642.

WRAS_240102021.

33 805 861

