









33 805 875



- 166mm projection
- pivotable spout 360°
- laminar flow
- height of mixer 303 mm
- height up to laminar flow regulator 186 mm
- hole diameter 35 mm
- max. flow 8 l/min at 3 bar flow pressure
- lead-free
- This product can help a building meet the requirements of Green Building Rating Systems, e.g. LEED®, BREEAM®, DGNB

	Chrome	33 805 875-00
	Brushed Platinum	33 805 875-06
	Platinum	33 805 875-08
	Durabrace (23kt Gold)	33 805 875-09
	Dark Chrome	33 805 875-19
	Brushed Durabrace (23kt Gold)	33 805 875-28
	Matte Black	33 805 875-33
	Brushed Champagne (22kt Gold)	33 805 875-46
	Champagne (22kt Gold)	33 805 875-47
	Brushed Chrome	33 805 875-93
	Brushed Dark Platinum	33 805 875-99

Recommended miscellaneous

Strainer waste with control handle - Chrome 10 712 970-00



Recommended miscellaneous

Dispenser without rosette - Chrome 82 424 970-00



33 805 875

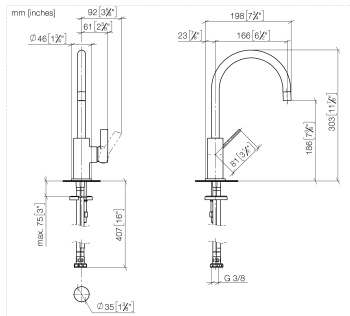

Flow rate chart

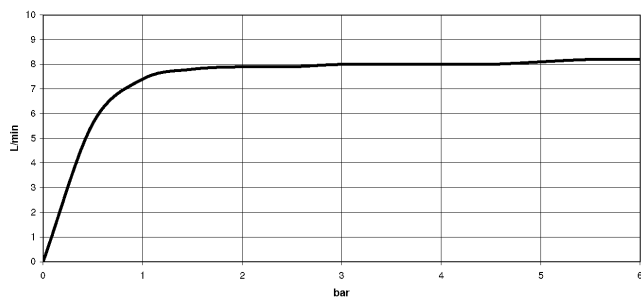

Certificates

LGA_18899.

33 805 875

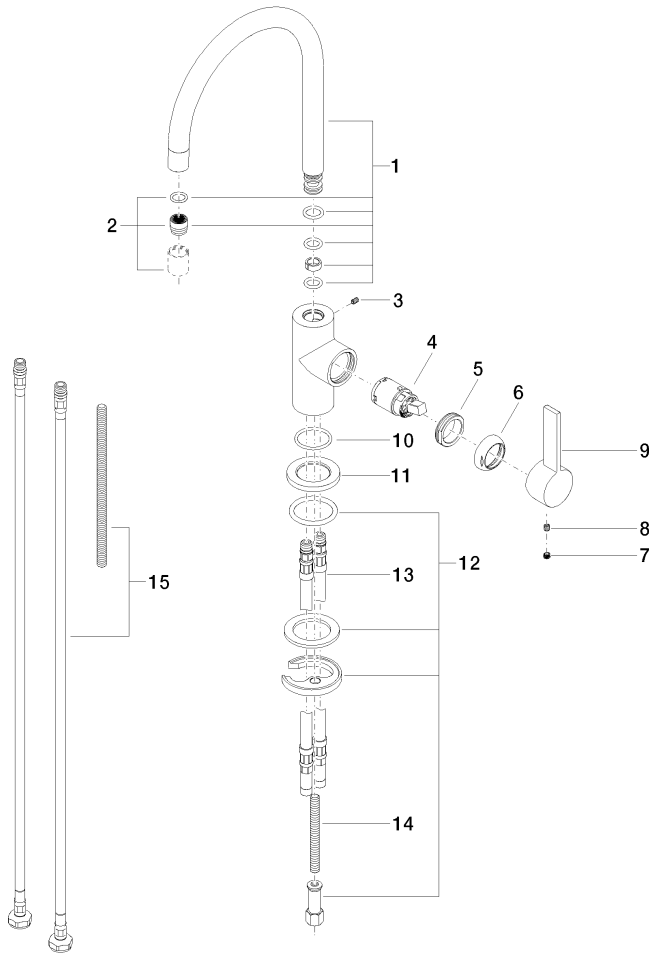

Spare parts list

No.	Item Number	Name	Quantity used	Delivery time
1	90 28 22 206 00-00	spout	1	10
2	90 23 01 067 00-00	aerator	1	10
3	09 31 11 008 90	pin	1	2
4	90 15 05 041 00 90	cartridge	1	2
5	09 24 04 130-07	nut	1	30
6	09 24 04 204-00	cover	1	10
7	90 31 20 109 00 90	plug	1	2
8	90 31 11 030 00 90	pin	1	2
9	09 20 88 051-00	handle	1	10
10	09 14 10 118 90	seal	1	2
11	09 27 85 001-00	rosette	1	10
12	04 30 11 038 64 90	fixing set	1	2
13	04 30 04 016 00 90	hose	2	60
14	09 31 11 011 90	pin	1	2
15	12 803 970 90	extension	1	60