



## Concealed single-lever mixer with backflow preventor -

---

35 021 970 90



- lead-free, dezincification resistant
- safety combination
- 2x back flow preventer
- 2x male thread 1/2" connection
- 3x outlet G 1/2"
- dust cover
- anti-water packing
- sound and thermal insulation
- 2x integrated supply stop
- gauge 60 mm
- WRAS 2207012

---

### Recommended miscellaneous

**Extension 25 mm -**

12 191 970 90



---

### Recommended miscellaneous

**Extension 25 mm -**

12 190 970 90



---

### Recommended miscellaneous

**xGRID Attachment set for  
integrating in the dry wall  
construction -**

12 340 970 90



---

### Required miscellaneous

**xGRID Installation track 555 mm -** 12 360 970 90





## Concealed single-lever mixer with backflow preventor -

35 021 970 90

mm [inches]

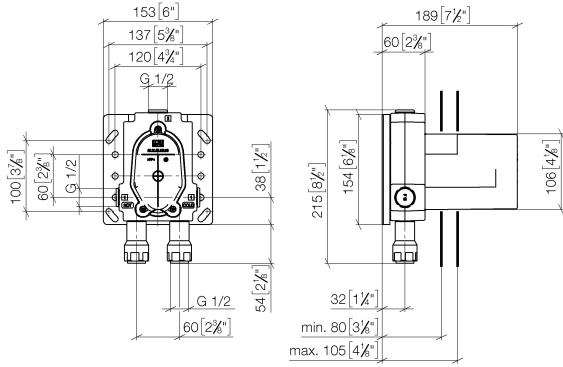

### Flow rate chart

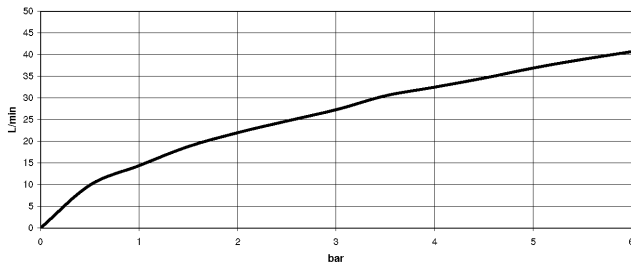

### Codes & Standards

DIN 4109

EN 1717

EN 817

ISO 3822

Scottish Water  
Byelaws

UK Water Supply  
Regulations

Ü-Zeichen



## Concealed single-lever mixer with backflow preventor -

---

35 021 970 90

### Certificates

---

DVGW\_DW-  
6512DN0

WRAS\_2207

LGA\_19

Belgaqua\_21-385-  
27

Concealed single-lever mixer with backflow preventor -

---

35 021 970 90

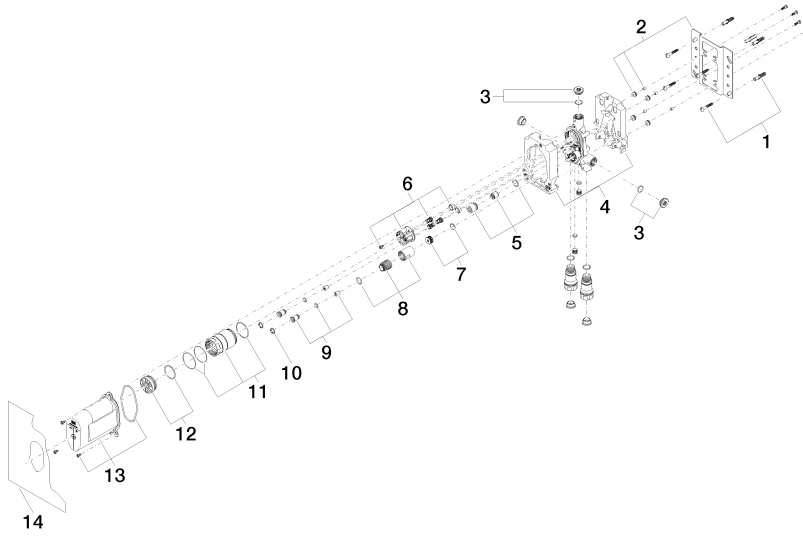



## Concealed single-lever mixer with backflow preventor -

---

35 021 970 90

### Spare parts list

No.	Item Number	Name	Quantity used	Delivery time
	04 30 31 024 01 90	fixing set	18	2