

Shower set - Brushed Platinum

TARA

ST 050 201 5660



Fits: TARA, META

- slide bar
- Pipe diameter 18 mm
- rosette Ø 55 mm
- gauge 800 mm
- metal shower hose 1750mm with integrated anti-twist protection
- shower hose connector 3/8"
- Three or five settings: COMPACT RAIN, COMPACT SOFT FLOW, COMPACT AQUAPRESSURE FLOW, max. flow rate 15 l/min (at 3 bar)
- Function from: 7 l/min
- spray head Ø 100mm

| | | |
|-------------------------------------------------------------------------------------|--------------------------------|--------------------|
|  | Brushed Platinum | ST 050 201 5660-06 |
|  | Chrome | ST 050 201 5660-00 |
|  | Platinum | ST 050 201 5660-08 |
|  | Dark Chrome | ST 050 201 5660-19 |
|  | Light Gold | ST 050 201 5660-26 |
|  | Brushed Light Gold | ST 050 201 5660-27 |
|  | Brushed Durabronze (23kt Gold) | ST 050 201 5660-28 |
|  | Matte Black | ST 050 201 5660-33 |
|  | Brushed Bronze | ST 050 201 5660-42 |
|  | Brushed Champagne (22kt Gold) | ST 050 201 5660-46 |
|  | Champagne (22kt Gold) | ST 050 201 5660-47 |
|  | Brushed Chrome | ST 050 201 5660-93 |
|  | Brushed Dark Platinum | ST 050 201 5660-99 |

Individual components of this set

You need the following components for this set



1x 26 413 625-06



1x 28 018 979-06



Shower set - Brushed Platinum

TARA

ST 050 201 5660













ST 050 201 5660



Fits: TARA, META

- slide bar
- Pipe diameter 18 mm
- rosette Ø 55 mm
- gauge 800 mm
- metal shower hose 1750mm with integrated anti-twist protection
- shower hose connector 3/8"
- WRAS 2009048

This article does not include a hand shower!

| | | |
|-------------------------------------------------------------------------------------|-------------------------------------|---------------|
|  | Brushed Platinum | 26 413 625-06 |
|  | Chrome | 26 413 625-00 |
|  | Platinum | 26 413 625-08 |
|  | Dark Chrome | 26 413 625-19 |
|  | Light Gold | 26 413 625-26 |
|  | Brushed Light Gold | 26 413 625-27 |
|  | Brushed Durabross (23kt Gold) | 26 413 625-28 |
|  | Matte Black | 26 413 625-33 |
|  | Brushed Bronze | 26 413 625-42 |
|  | Brushed Champagne (22kt Gold) | 26 413 625-46 |
|  | Champagne (22kt Gold) | 26 413 625-47 |
|  | Brushed Chrome | 26 413 625-93 |
|  | Brushed Dark Platinum | 26 413 625-99 |

ST 050 201 5660

Recommended miscellaneous

| | | |
|-----------------------------------------------------------------------------------|----------------------------------------------------------------------------------------|---------------|
|  | Concealed wall elbow - ●min. recess depth 90 mm ●max. recess depth 163 mm | 35 085 970 90 |
|-----------------------------------------------------------------------------------|----------------------------------------------------------------------------------------|---------------|

Required miscellaneous

| | | |
|-----------------------------------------------------------------------------------|---------------------------------------|---------------|
|  | Hand shower - Brushed Platinum | 28 012 979-06 |
|-----------------------------------------------------------------------------------|---------------------------------------|---------------|

Required miscellaneous

| | | |
|-----------------------------------------------------------------------------------|---------------------------------------|---------------|
|  | Hand shower - Brushed Platinum | 28 017 979-06 |
|-----------------------------------------------------------------------------------|---------------------------------------|---------------|

Required miscellaneous

| | | |
|-----------------------------------------------------------------------------------|---------------------------------------|---------------|
|  | Hand shower - Brushed Platinum | 28 016 979-06 |
|-----------------------------------------------------------------------------------|---------------------------------------|---------------|

Required miscellaneous

| | | |
|-------------------------------------------------------------------------------------|------------------------------------------------------|-----------------------|
|  | Hand shower FlowReduce - Brushed Platinum | 28 018 979-06 0010 |
|-------------------------------------------------------------------------------------|------------------------------------------------------|-----------------------|

Required miscellaneous

| | | |
|-------------------------------------------------------------------------------------|----------------------------------------------------------|---------------|
|  | SERIES-VARIOUS Hand shower - Brushed Platinum | 28 029 979-06 |
|-------------------------------------------------------------------------------------|----------------------------------------------------------|---------------|

Required miscellaneous

| | | |
|-------------------------------------------------------------------------------------|----------------------------------------------------------|-----------------------|
|  | SERIES-VARIOUS Hand shower - Brushed Platinum | 28 025 979-06 0010 |
|-------------------------------------------------------------------------------------|----------------------------------------------------------|-----------------------|

Recommended miscellaneous

| | | |
|-----------------------------------------------------------------------------------|--------------------------------------|---------------|
|  | Wall elbow - Brushed Platinum | 28 450 625-06 |
|-----------------------------------------------------------------------------------|--------------------------------------|---------------|

Required miscellaneous

| | | |
|-----------------------------------------------------------------------------------|------------------------------------------------------|-----------------------|
|  | Hand shower FlowReduce - Brushed Platinum | 28 016 979-06 0010 |
|-----------------------------------------------------------------------------------|------------------------------------------------------|-----------------------|

Required miscellaneous

| | | |
|-----------------------------------------------------------------------------------|------------------------------------------------------|-----------------------|
|  | Hand shower FlowReduce - Brushed Platinum | 28 012 979-06 0010 |
|-----------------------------------------------------------------------------------|------------------------------------------------------|-----------------------|

Required miscellaneous

| | | |
|-----------------------------------------------------------------------------------|---------------------------------------|---------------|
|  | Hand shower - Brushed Platinum | 28 018 979-06 |
|-----------------------------------------------------------------------------------|---------------------------------------|---------------|

Required miscellaneous

| | | |
|-------------------------------------------------------------------------------------|----------------------------------------------------------|-----------------------|
|  | SERIES-VARIOUS Hand shower - Brushed Platinum | 28 029 979-06 0010 |
|-------------------------------------------------------------------------------------|----------------------------------------------------------|-----------------------|

Required miscellaneous

| | | |
|-------------------------------------------------------------------------------------|----------------------------------------------------------|-----------------------|
|  | SERIES-VARIOUS Hand shower - Brushed Platinum | 28 027 979-06 0010 |
|-------------------------------------------------------------------------------------|----------------------------------------------------------|-----------------------|



Shower set - Brushed Platinum

TARA

ST 050 201 5660

ST 050 201 5660

mm [inches]

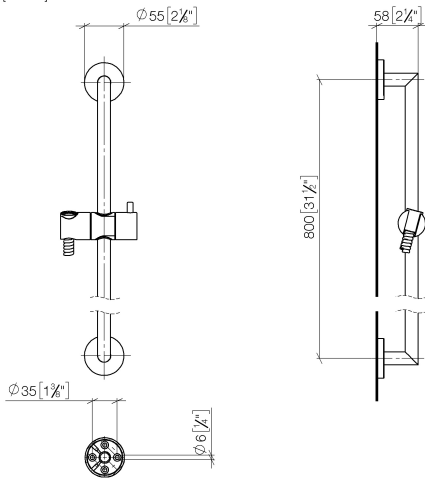

Certificates

WRAS_2009048. ACS_20 ACC LY 738. IAPMO_4976 (4).

ST 050 201 5660

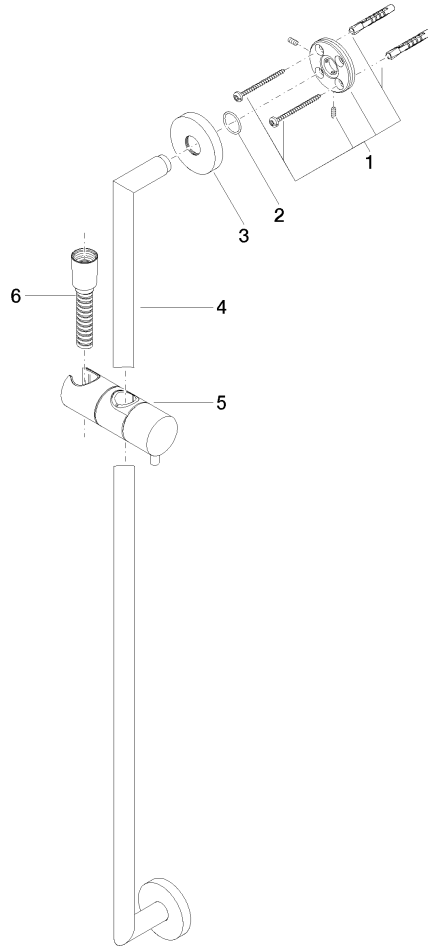

Spare parts list

| No. | Item Number | Name | Quantity used | Delivery time |
|-----|--------------------|------------------------------------------------------------|---------------|---------------|
| 1 | 05 17 62 500 00 90 | fixing set | 2 | 2 |
| 2 | 90 14 10 032 00 90 | seal | 2 | 2 |
| 3 | 08 27 62 500-06 | rosette | 2 | 10 |
| 4 | 05 28 22 590 01-06 | bar | 1 | 10 |
| 5 | 12 580 970-06 | Slide unit - Brushed Platinum | 1 | 10 |
| 6 | 28 322 970-06 | Metal shower hose 1/2" x 3/8" x 1750 mm - Brushed Platinum | 1 | 2 |





























ST 050 201 5660



- Three or five settings: COMPACT RAIN, COMPACT SOFT FLOW, COMPACT AQUAPRESSURE FLOW, max. flow rate 15 l/min (at 3 bar)
- with anti-scale system
- spray head Ø 100mm
- 1/2" connection
- WRAS 2210003
- Function from: 7 l/min

Intrinsic protection against back flow.

Fits: IMO, LULU, MADISON, MEM, TARA, CL.1, LISSÉ, VAIA, META, CYO

| | | |
|--------------------------------------------------------------------------------------|--------------------------------|--------------------|
|  | Brushed Platinum | 28 018 979-06 |
|  | Chrome | 28 018 979-00 |
|  | Chrome | 28 018 979-00 0010 |
|  | Brushed Platinum | 28 018 979-06 0010 |
|  | Platinum | 28 018 979-08 |
|  | Platinum | 28 018 979-08 0010 |
|  | Dark Brass matt | 28 018 979-16 0010 |
|  | Dark Bronze matt | 28 018 979-17 0010 |
|  | Dark Chrome | 28 018 979-19 |
|  | Dark Chrome | 28 018 979-19 0010 |
|  | Light Gold | 28 018 979-26 0010 |
|  | Light Gold | 28 018 979-26 |
|  | Brushed Light Gold | 28 018 979-27 0010 |
|  | Brushed Light Gold | 28 018 979-27 |
|  | Brushed Durabronze (23kt Gold) | 28 018 979-28 |
|  | Brushed Durabronze (23kt Gold) | 28 018 979-28 0010 |
|  | Matte Black | 28 018 979-33 |
|  | Matte Black | 28 018 979-33 0010 |
|  | Brushed Bronze | 28 018 979-42 0010 |
|  | Brushed Bronze | 28 018 979-42 |
|  | Brushed Champagne (22kt Gold) | 28 018 979-46 |
|  | Brushed Champagne (22kt Gold) | 28 018 979-46 0010 |
|  | Champagne (22kt Gold) | 28 018 979-47 |
|  | Champagne (22kt Gold) | 28 018 979-47 0010 |
|  | Brushed Chrome | 28 018 979-93 |
|  | Brushed Chrome | 28 018 979-93 0010 |
|  | Brushed Dark Platinum | 28 018 979-99 |
|  | Brushed Dark Platinum | 28 018 979-99 0010 |



Shower set - Brushed Platinum

TARA

ST 050 201 5660



Shower set - Brushed Platinum

TARA

ST 050 201 5660



Shower set - Brushed Platinum

TARA

ST 050 201 5660

ST 050 201 5660

mm [inches]

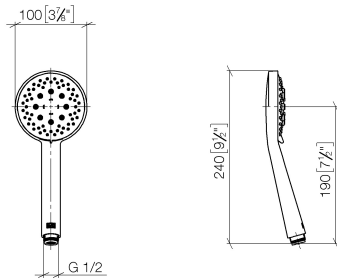

Flow rate chart

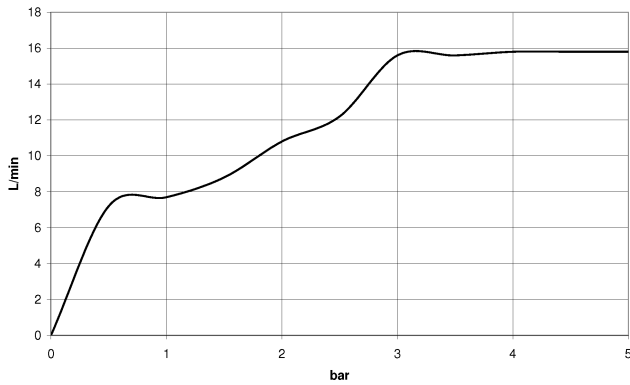

Certificates

LGA_29984.

DVGW_DW-
6517DN0129.

WRAS_2210003.

ST 050 201 5660

Parts for other
finishes can be found
here: [Chrome](#)

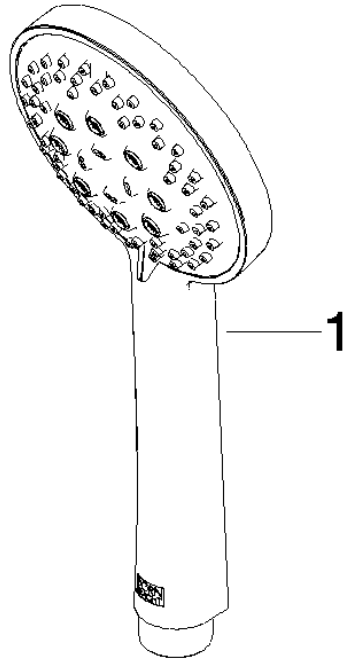

Spare parts list

| No. | Item Number | Name | Quantity used | Delivery time |
|-----|-----------------|-------|---------------|---------------|
| 1 | 09 23 01 039 90 | sieve | 1 | 2 |