

ST 050 203 1892



- slide bar
- Pipe diameter 18 mm
- rosettes Ø 55 mm
- gauge 800 mm
- metal shower hose 1750mm with integrated anti-twist protection
- shower hose connector 3/8"
- Three or five settings: COMPACT RAIN, COMPACT SOFT FLOW, COMPACT AQUAPRESSURE FLOW, max. flow rate 15 l/min (at 3 bar)
- Function from: 7 l/min
- spray head Ø 100mm

	Brushed Chrome	ST 050 203 1892-93
	Chrome	ST 050 203 1892-00
	Brushed Platinum	ST 050 203 1892-06
	Platinum	ST 050 203 1892-08
	Dark Chrome	ST 050 203 1892-19
	Brushed Durabrass (23kt Gold)	ST 050 203 1892-28
	Matte Black	ST 050 203 1892-33
	Brushed Champagne (22kt Gold)	ST 050 203 1892-46
	Champagne (22kt Gold)	ST 050 203 1892-47
	Brushed Dark Platinum	ST 050 203 1892-99

Individual components of this set

You need the following components for this set



1x 26 413 892-93



1x 28 018 979-93



TARA Shower set - Brushed Chrome

TARA

ST 050 203 1892

ST 050 203 1892



- slide bar
- Pipe diameter 18 mm
- rosettes Ø 55 mm
- gauge 800 mm
- metal shower hose 1750mm with integrated anti-twist protection
- shower hose connector 3/8"
- WRAS 2009048

This article does not include a hand shower!

	Brushed Chrome	26 413 892-93
	Chrome	26 413 892-00
	Brushed Platinum	26 413 892-06
	Platinum	26 413 892-08
	Dark Chrome	26 413 892-19
	Brushed Durabross (23kt Gold)	26 413 892-28
	Matte Black	26 413 892-33
	Brushed Champagne (22kt Gold)	26 413 892-46
	Champagne (22kt Gold)	26 413 892-47
	Brushed Dark Platinum	26 413 892-99

ST 050 203 1892

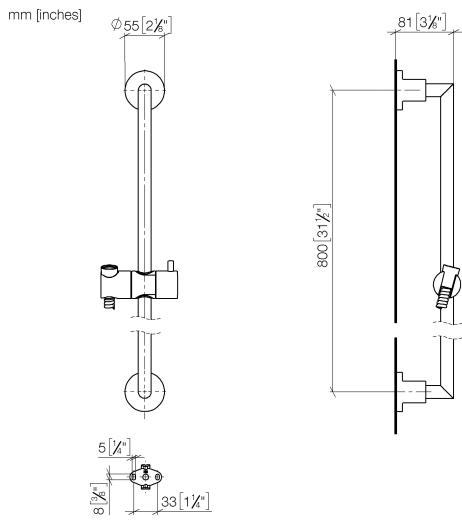

Certificates

WRAS_2009048. ACS_20 ACC LY 738. IAPMO_4976 (2).

ST 050 203 1892

Parts for other finishes can be found here: [Chrome](#)

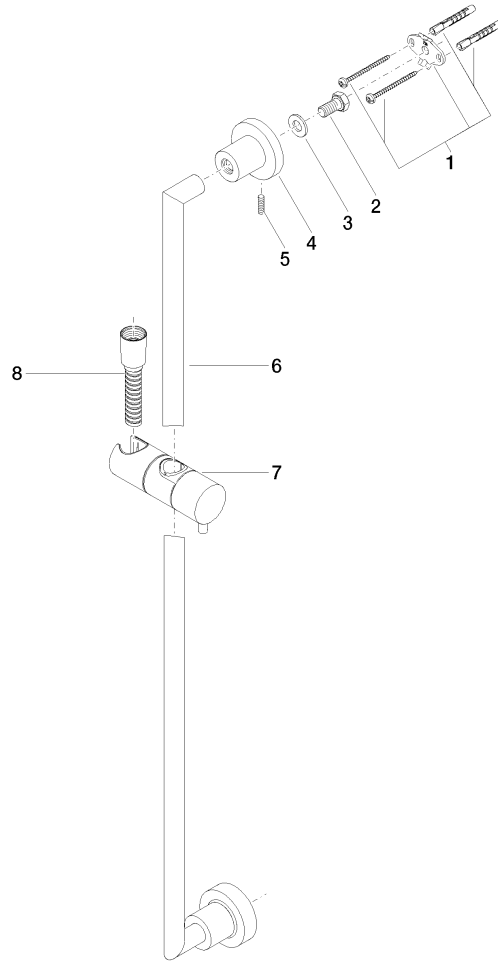

Spare parts list

No.	Item Number	Name	Quantity used	Delivery time
1	05 17 20 739 00 90	fixing set	2	2
2	09 30 30 071 90	screw	2	2
3	09 30 11 046 90	disc	2	2
4	08 17 89 505-93	holder	2	20
5	04 31 11 113 00 90	pin	2	2
6	05 28 22 590 00-93	bar	1	20
7	12 580 970-93	Slide unit - Brushed Chrome	1	20
8	28 322 970-93	Metal shower hose 1/2" x 3/8" x 1750 mm - Brushed Chrome	1	20





























ST 050 203 1892



- Three or five settings: COMPACT RAIN, COMPACT SOFT FLOW, COMPACT AQUAPRESSURE FLOW, max. flow rate 15 l/min (at 3 bar)
- with anti-scale system
- spray head Ø 100mm
- 1/2" connection
- WRAS 2210003
- Function from: 7 l/min

Intrinsic protection against back flow.

Fits: IMO, LULU, MADISON, MEM, TARA, CL.1, LISSÉ, VAIA, META, CYO

	Brushed Chrome	28 018 979-93
	Chrome	28 018 979-00
	Chrome	28 018 979-00 0010
	Brushed Platinum	28 018 979-06
	Brushed Platinum	28 018 979-06 0010
	Platinum	28 018 979-08
	Platinum	28 018 979-08 0010
	Dark Brass matt	28 018 979-16 0010
	Dark Bronze matt	28 018 979-17 0010
	Dark Chrome	28 018 979-19
	Dark Chrome	28 018 979-19 0010
	Light Gold	28 018 979-26 0010
	Light Gold	28 018 979-26
	Brushed Light Gold	28 018 979-27 0010
	Brushed Light Gold	28 018 979-27
	Brushed Durabrass (23kt Gold)	28 018 979-28
	Brushed Durabrass (23kt Gold)	28 018 979-28 0010
	Matte Black	28 018 979-33
	Matte Black	28 018 979-33 0010
	Brushed Bronze	28 018 979-42 0010
	Brushed Bronze	28 018 979-42
	Brushed Champagne (22kt Gold)	28 018 979-46
	Brushed Champagne (22kt Gold)	28 018 979-46 0010
	Champagne (22kt Gold)	28 018 979-47
	Champagne (22kt Gold)	28 018 979-47 0010
	Brushed Chrome	28 018 979-93 0010
	Brushed Dark Platinum	28 018 979-99
	Brushed Dark Platinum	28 018 979-99 0010



TARA Shower set - Brushed Chrome

TARA

ST 050 203 1892



TARA Shower set - Brushed Chrome

TARA

ST 050 203 1892



TARA Shower set - Brushed Chrome

TARA

ST 050 203 1892

ST 050 203 1892

mm [inches]

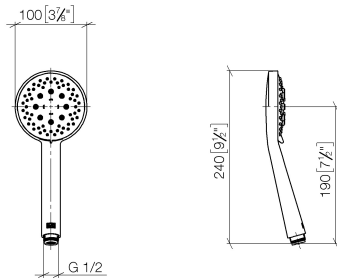

Flow rate chart

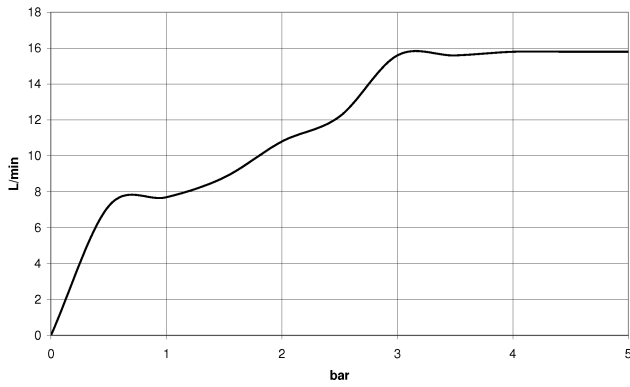

Certificates

LGA_29984.

DVGW_DW-
6517DN0129.

WRAS_2210003.

ST 050 203 1892

Parts for other
finishes can be found
here: [Chrome](#)

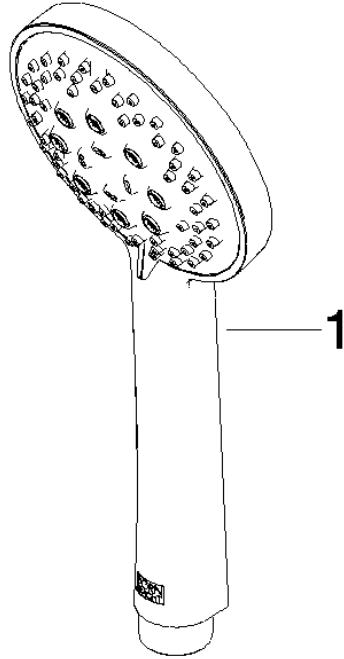

Spare parts list

No.	Item Number	Name	Quantity used	Delivery time
1	09 23 01 039 90	sieve	1	2