

Showerpipe with single-lever shower mixer - Chrome

IMO

ST 050 306 7979



Fits: IMO, LULU, TARA, LISSÉ, VAIA, META, CYO

- shower with fixed riser projection 450mm
 - Rain shower: PURE RAIN, max. flow rate 14 l/min (at 3 bar)
 - rain shower Ø 220 mm
 - rain shower with anti-scale system
 - Hand shower: COMPACT RAIN, max. flow rate 15 l/min (at 3 bar)
 - spray head Ø 100mm
 - height of fittings up to rain shower (bottom edge) 1010mm
 - height of fittings up to top edge of elbow 1150mm
 - metal shower hose 1750mm with integrated anti-twist protection
 - 1/2" connection
 - slide bar
 - Pipe diameter 23.5 mm
 - automatic diverter for fixed-riser shower/hand shower
- Intrinsic protection against back flow.**

| | | |
|--|--------------------------------|--------------------|
|  | Chrome | ST 050 306 7979-00 |
|  | Brushed Platinum | ST 050 306 7979-06 |
|  | Platinum | ST 050 306 7979-08 |
|  | Dark Chrome | ST 050 306 7979-19 |
|  | Brushed Durabronze (23kt Gold) | ST 050 306 7979-28 |
|  | Matte Black | ST 050 306 7979-33 |
|  | Brushed Champagne (22kt Gold) | ST 050 306 7979-46 |
|  | Champagne (22kt Gold) | ST 050 306 7979-47 |
|  | Brushed Dark Platinum | ST 050 306 7979-99 |

Individual components of this set

You need the following components for this set



1x 28 015 979-00



1x 36 112 970-00



Showerpipe with single-lever shower mixer - Chrome

IMO

ST 050 306 7979

Showerpipe with single-lever shower mixer - Chrome

IMO



























ST 050 306 7979



- COMPACT RAIN, max. flow rate 15 l/min (at 3 bar)
- with anti-scale system
- spray head Ø 100mm
- 1/2" connection
- WRAS 2009011

Intrinsic protection against back flow.

Fits: IMO, LULU, MADISON, MEM, TARA,
CL.1, LISSÉ, VAIA, META, CYO

| | | |
|--|-------------------------------------|--------------------|
|  | Chrome | 28 015 979-00 |
|  | Chrome | 28 015 979-00 0010 |
|  | Brushed Platinum | 28 015 979-06 |
|  | Brushed Platinum | 28 015 979-06 0010 |
|  | Platinum | 28 015 979-08 |
|  | Platinum | 28 015 979-08 0010 |
|  | Dark Chrome | 28 015 979-19 |
|  | Dark Chrome | 28 015 979-19 0010 |
|  | Light Gold | 28 015 979-26 |
|  | Light Gold | 28 015 979-26 0010 |
|  | Brushed Light Gold | 28 015 979-27 0010 |
|  | Brushed Light Gold | 28 015 979-27 |
|  | Brushed Durabronze (23kt Gold) | 28 015 979-28 |
|  | Brushed Durabronze (23kt Gold) | 28 015 979-28 0010 |
|  | Matte Black | 28 015 979-33 |
|  | Matte Black | 28 015 979-33 0010 |
|  | Brushed Bronze | 28 015 979-42 |
|  | Brushed Bronze | 28 015 979-42 0010 |
|  | Brushed Champagne (22kt Gold) | 28 015 979-46 |
|  | Brushed Champagne (22kt Gold) | 28 015 979-46 0010 |
|  | Champagne (22kt Gold) | 28 015 979-47 |
|  | Champagne (22kt Gold) | 28 015 979-47 0010 |
|  | Brushed Chrome | 28 015 979-93 |
|  | Brushed Chrome | 28 015 979-93 0010 |
|  | Brushed Dark Platinum | 28 015 979-99 |
|  | Brushed Dark Platinum | 28 015 979-99 0010 |



Showerpipe with single-lever shower mixer - Chrome

IMO

ST 050 306 7979



Showerpipe with single-lever shower mixer - Chrome

IMO

ST 050 306 7979

ST 050 306 7979

mm [inches]



Flow rate chart



Certificates

DVGW_DW-6517DN0129. WRAS_2009011. LGA_29981.



Spare parts list

| No. | Item Number | Name | Quantity used | Delivery time |
|-----|-----------------|-------|---------------|---------------|
| 1 | 09 23 01 039 90 | sieve | 1 | 2 |

Showerpipe with single-lever shower mixer - Chrome

IMO

ST 050 306 7979



Fits: IMO, LULU, TARA, LISSÉ, VAIA, META

- shower with fixed riser projection 450mm
- overhead shower: rain flow
- rain shower Ø 220 mm
- rain shower with anti-scale system
- max. rainshower flow 14 l/min
- height of fittings up to rain shower (bottom edge) 1010mm
- height of fittings up to top edge of elbow 1150mm
- metal shower hose 1750mm with integrated anti-twist protection
- 1/2" connection
- slide bar
- Pipe diameter 23.5 mm
- automatic diverter for fixed-riser shower/hand shower
- quick clearing
- WRAS 2101043

**This article does not include a hand shower!
Intrinsic protection against back flow.**

This article does not include a hand shower!
Intrinsic protection against back flow.

| | | |
|--|--------------------------------|---------------|
| | Chrome | 36 112 970-00 |
| | Brushed Platinum | 36 112 970-06 |
| | Platinum | 36 112 970-08 |
| | Dark Chrome | 36 112 970-19 |
| | Brushed Light Gold | 36 112 970-27 |
| | Brushed Durabronze (23kt Gold) | 36 112 970-28 |
| | Matte Black | 36 112 970-33 |
| | Brushed Bronze | 36 112 970-42 |
| | Brushed Champagne (22kt Gold) | 36 112 970-46 |
| | Champagne (22kt Gold) | 36 112 970-47 |
| | Brushed Chrome | 36 112 970-93 |
| | Brushed Dark Platinum | 36 112 970-99 |

Required miscellaneous

| | | |
|--|---|---------------|
| | Concealed wall mounting - •min. recess depth 80 mm •max. recess depth 105 mm | 35 050 970 90 |
|--|---|---------------|

Required miscellaneous

| | | |
|--|-----------------------------|---------------|
| | Hand shower - Chrome | 28 016 979-00 |
|--|-----------------------------|---------------|

Required miscellaneous

| | | |
|--|--|--------------------|
| | Hand shower FlowReduce - Chrome | 28 012 979-00 0010 |
|--|--|--------------------|

Required miscellaneous

| | | |
|--|-----------------------------|---------------|
| | Hand shower - Chrome | 28 018 979-00 |
|--|-----------------------------|---------------|

Required miscellaneous

| | | |
|--|--|--------------------|
| | SERIES-VARIOUS Hand shower - Chrome | 28 027 979-00 0010 |
|--|--|--------------------|

Required miscellaneous

| | | |
|--|--|---------------|
| | SERIES-VARIOUS Hand shower - Chrome | 28 029 979-00 |
|--|--|---------------|

Required miscellaneous

| | | |
|--|--|--------------------|
| | Hand shower FlowReduce - Chrome | 28 016 979-00 0010 |
|--|--|--------------------|

Required miscellaneous

| | | |
|--|-----------------------------|---------------|
| | Hand shower - Chrome | 28 017 979-00 |
|--|-----------------------------|---------------|

Required miscellaneous

| | | |
|--|-----------------------------|---------------|
| | Hand shower - Chrome | 28 012 979-00 |
|--|-----------------------------|---------------|

Required miscellaneous

| | | |
|--|--|--------------------|
| | Hand shower FlowReduce - Chrome | 28 018 979-00 0010 |
|--|--|--------------------|

Required miscellaneous

| | | |
|--|--|--------------------|
| | SERIES-VARIOUS Hand shower - Chrome | 28 029 979-00 0010 |
|--|--|--------------------|

Required miscellaneous

| | | |
|--|--|--------------------|
| | SERIES-VARIOUS Hand shower - Chrome | 28 025 979-00 0010 |
|--|--|--------------------|



Showerpipe with single-lever shower mixer - Chrome

IMO

ST 050 306 7979

ST 050 306 7979

mm [inches]
1:10

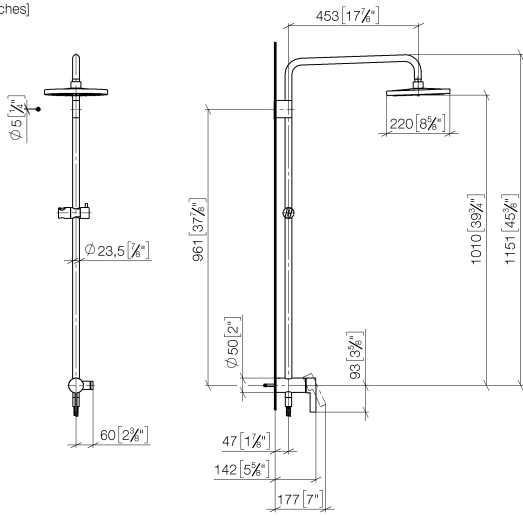

Flow rate chart

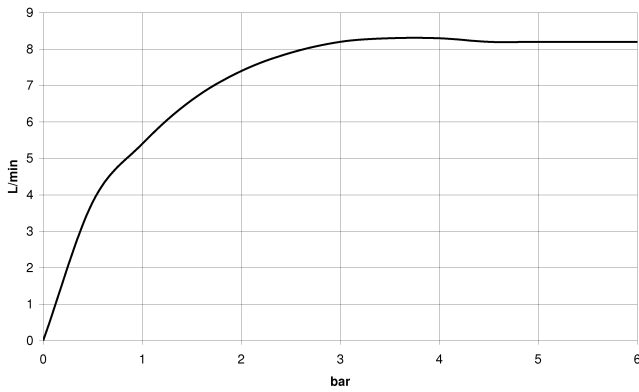

Certificates

DVGW_DW-
6512DN0126.

Belgaqua_21-025-
27_1.

WRAS_2101043.

LGA_38677.

ST 050 306 7979

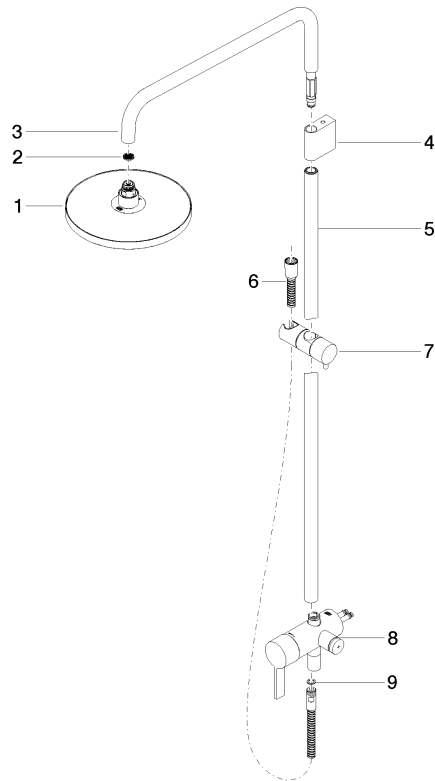

Spare parts list

| No. | Item Number | Name | Quantity used | Delivery time |
|-----|--------------------|--|---------------|---------------|
| 1 | 04 12 05 092 00-00 | shower | 1 | 10 |
| 2 | 09 23 01 039 90 | sieve | 1 | 2 |
| 3 | 90 28 22 348 00-00 | pipe | 1 | 10 |
| 4 | 90 17 11 149 00-00 | holder | 1 | 10 |
| 5 | 04 28 22 349 00-00 | pipe | 1 | 60 |
| 6 | 28 322 970-00 | Metal shower hose 1/2" x 3/8" x 1750 mm - Chrome | 1 | 2 |
| 7 | 12 570 970-00 | Slide unit - Chrome | 1 | 10 |
| 8 | 90 17 01 251 00-00 | connection | 1 | 10 |
| 9 | 90 14 20 026 00 90 | seal | 1 | 2 |