







CL.1 Deck valve anti-clockwise closing hot - Brushed Dark Platinum

CL.1

20 000 706



- hole diameter valve 32 mm
- rosette 60 x 60 mm
- with hot marking
- WRAS 2103001

	Brushed Dark Platinum	20 000 706-99
	Chrome	20 000 706-00
	Brushed Platinum	20 000 706-06
	Dark Chrome	20 000 706-19
	Brushed Champagne (22kt Gold)	20 000 706-46
	Champagne (22kt Gold)	20 000 706-47

20 000 706

mm [inches]

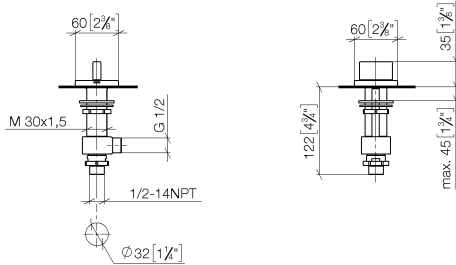

Flow rate chart



Codes & Standards

DIN 4109

ISO 3822

Scottish Water
Byelaws

UK Water Supply
Regulations

Ü-Zeichen



CL.1 Deck valve anti-clockwise closing hot - Brushed Dark Platinum

CL.1

20 000 706

Certificates

WRAS_2103

LGA_28

20 000 706

Product version from 3/9/2015

Parts for other finishes can be found here: [Chrome](#)

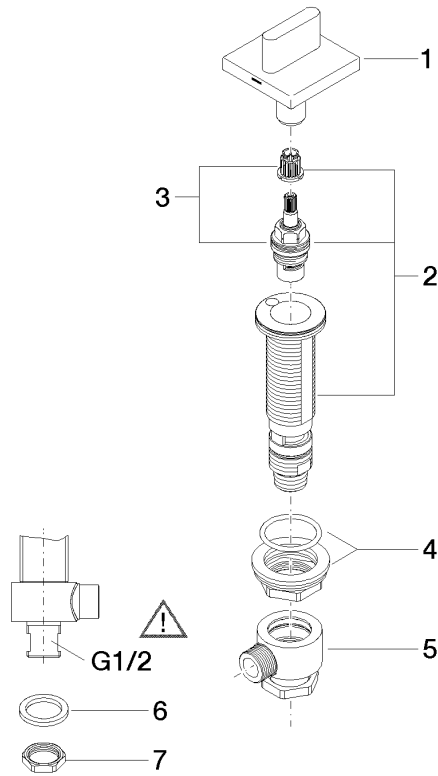



CL.1 Deck valve anti-clockwise closing hot - Brushed Dark Platinum

CL.1

20 000 706

Spare parts list

Product version from 3/9/2015

No.	Item Number	Name	Quantity used	Delivery time
	90 20 70 051 05-99	handle (hot)	8	30