

22 815 892



- 235mm projection
- pivotable spout 360°
- air-enriched flow
- height of mixer 378 mm
- height up to aerator 220 mm
- hole diameter 35 mm
- max. flow 7 l/min at 3 bar flow pressure
- lead-free
- This product can help a building meet the requirements of Green Building Rating Systems, e.g. LEED®, BREEAM®, DGNB
- WRAS 1810003

	Platinum	22 815 892-08
	Chrome	22 815 892-00
	Brushed Platinum	22 815 892-06
	Durabronze (23kt Gold)	22 815 892-09
	Dark Chrome	22 815 892-19
	Brushed Durabronze (23kt Gold)	22 815 892-28
	Matte Black	22 815 892-33
	Brushed Champagne (22kt Gold)	22 815 892-46
	Champagne (22kt Gold)	22 815 892-47
	Brushed Chrome	22 815 892-93
	Brushed Dark Platinum	22 815 892-99

Recommended miscellaneous

Strainer waste with control handle - Platinum 10 710 970-08



Recommended miscellaneous

Dispenser with rosette - Platinum 82 444 970-08



22 815 892

mm [inches]

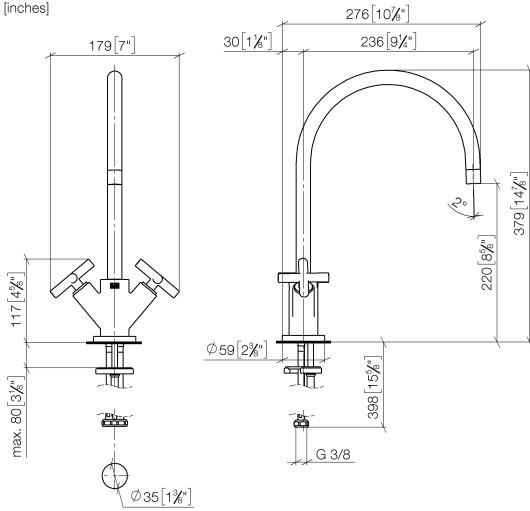

Flow rate chart



Codes & Standards

DIN 4109

EN 200

Executive Order
no. 1007

ISO 3822

Scottish Water
Byelaws

UK Water Supply
Regulations

Ü-Zeichen

VA-Zeichen



TARA Single-hole mixer - Platinum

TARA

22 815 892

Certificates

GDV_0400

LGA_19

ETA_18

WRAS_1810

22 815 892

Product version from 6/30/2009 to 5/27/2021

Product version from 5/27/2021

Parts for other
finishes can be found
here: [Chrome](#)

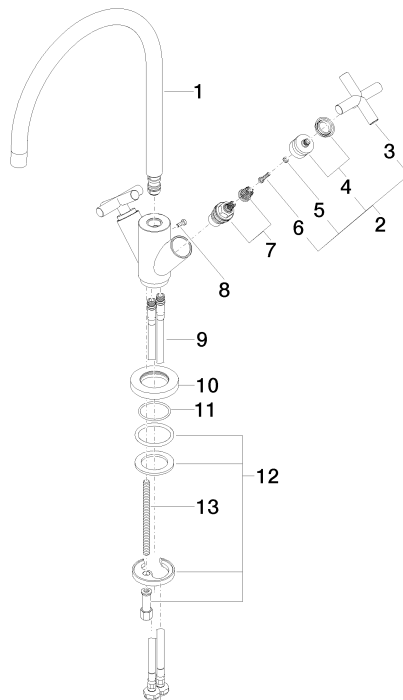



TARA Single-hole mixer - Platinum

TARA

22 815 892

Spare parts list

Product version from 6/30/2009 to 5/27/2021

Product version from 5/27/2021

No.	Item Number	Name	Quantity used	Delivery time
	90 28 22 226 01-08	spout	20	40