

## Shower head - Brushed Dark Platinum













TARA

28 504 979 Product version from 4/1/2024



- 180-210mm projection
- ball-joint pivotable through 30°
- PURIFY RAIN, max. flow rate 7 l/min (at 3 bar)
- Function from: 6 l/min
- with anti-scale system
- spray head Ø 100mm
- rosette Ø 55 mm
- 1/2" connection

Fits: TARA, LISSÉ, VAIA, META

	Brushed Dark Platinum	28 504 979-99
	Chrome	28 504 979-00
	Brushed Platinum	28 504 979-06
	Platinum	28 504 979-08
	Dark Chrome	28 504 979-19
	Light Gold	28 504 979-26
	Brushed Light Gold	28 504 979-27
	Brushed Durabronze (23kt Gold)	28 504 979-28
	Matte Black	28 504 979-33
	Brushed Bronze	28 504 979-42
	Brushed Champagne (22kt Gold)	28 504 979-46
	Champagne (22kt Gold)	28 504 979-47
	Brushed Chrome	28 504 979-93

### Recommended miscellaneous



- Concealed wall elbow -** 35 085 970 90
- max. recess depth mm
  - min. recess depth mm

28 504 979 Product version from 4/1/2024

mm [inches]

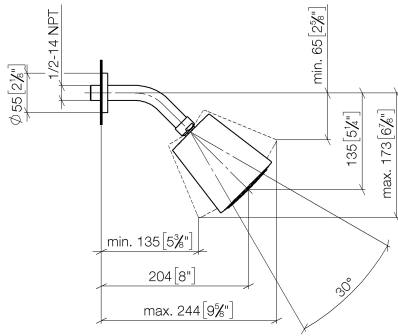

Flow rate chart

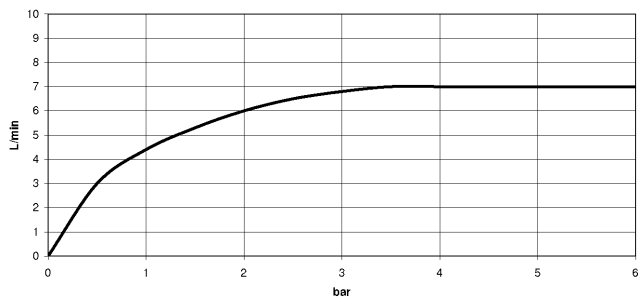

Codes & Standards

DIN 4109

EN 1112

ISO 3822

Ü-Zeichen



## Shower head - Brushed Dark Platinum

---

TARA

28 504 979 Product version from 4/1/2024

### Certificates

---

DVGW\_DW- LGA\_19  
6517DN0

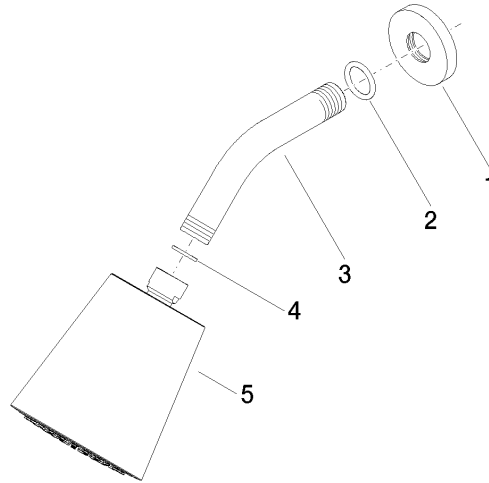

### Spare parts list

No.	Item Number	Name	Quantity used	Delivery time
1	09 27 22 003-99	rosette	1	30
2	90 14 10 026 00 90	seal	1	2
3	09 11 03 011-99	connection	1	30
4	90 14 20 002 00 90	seal	1	2
5	90 12 05 054 00-99	shower	1	30