

Shower head FlowReduce - Brushed Durabrass (23kt Gold)























TARA

28 508 979 Product version from 5/15/2020



Fits: TARA, LISSÉ, VAIA, META

- 200mm projection
- ball-joint pivotable through 30°
- Three settings: PURIFY RAIN, COMPACT SOFT FLOW, COMPACT AQUAPRESSURE FLOW, max. flow rate 6.8 l/min (at 3 bar)
- with anti-scale system
- spray head Ø 92mm
- rosette Ø 55 mm
- 1/2" connection
- This product can help a building meet the requirements of Green Building Rating Systems, e.g. LEED®, BREEAM®, DGNB

	Brushed Durabrass (23kt Gold)	28 508 979-28 0010
	Chrome	28 508 979-00 0010
	Chrome	28 508 979-00
	Brushed Platinum	28 508 979-06 0010
	Brushed Platinum	28 508 979-06
	Platinum	28 508 979-08 0010
	Platinum	28 508 979-08
	Dark Chrome	28 508 979-19 0010
	Dark Chrome	28 508 979-19
	Light Gold	28 508 979-26 0010
	Light Gold	28 508 979-26
	Brushed Light Gold	28 508 979-27 0010
	Brushed Light Gold	28 508 979-27
	Brushed Durabrass (23kt Gold)	28 508 979-28
	Matte Black	28 508 979-33 0010
	Matte Black	28 508 979-33
	Brushed Bronze	28 508 979-42 0010
	Brushed Bronze	28 508 979-42
	Brushed Champagne (22kt Gold)	28 508 979-46 0010
	Brushed Champagne (22kt Gold)	28 508 979-46
	Champagne (22kt Gold)	28 508 979-47 0010
	Champagne (22kt Gold)	28 508 979-47
	Brushed Chrome	28 508 979-93 0010
	Brushed Chrome	28 508 979-93
	Brushed Dark Platinum	28 508 979-99 0010
	Brushed Dark Platinum	28 508 979-99



Shower head FlowReduce - Brushed Durabrass (23kt Gold)

TARA

28 508 979 Product version from 5/15/2020

28 508 979 Product version from 5/15/2020

mm [inches]



Flow rate chart



Codes & Standards

DIN 4109

ISO 3822

Ü-Zeichen



Shower head FlowReduce - Brushed Durabrass (23kt Gold)

TARA

28 508 979 Product version from 5/15/2020

Certificates

LGA_38

28 508 979 Product version from 5/15/2020

Parts for other finishes can be found here: [Chrome](#)

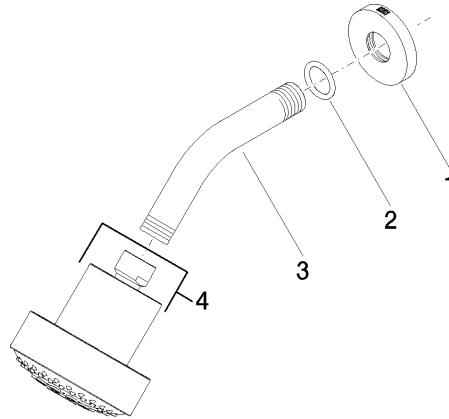

Spare parts list

No.	Item Number	Name	Quantity used	Delivery time
1	09 27 22 019-28	rosette	1	20
2	90 14 10 026 00 90	seal	1	2
3	09 11 03 011-28	connection	1	20
4	04 12 11 110 30-28	shower	1	-

Spare part can no longer be ordered, please order the replacement item