

**Rain shower with wall fixing 300 mm - Platinum**













TARA

28 679 970



- 450mm projection
- rain shower Ø 300 mm
- PURE RAIN, max. flow rate 14 l/min (at 3 bar)
- Function from: 10 l/min
- rosette Ø 60 mm
- 1/2" connection
- with anti-scale system
- quick clearing
- WRAS 2212012

Fits: TARA, LISSÉ, VAIA, META

	Platinum	28 679 970-08
	Chrome	28 679 970-00
	Brushed Platinum	28 679 970-06
	Dark Chrome	28 679 970-19
	Light Gold	28 679 970-26
	Brushed Light Gold	28 679 970-27
	Brushed Durabronze (23kt Gold)	28 679 970-28
	Matte Black	28 679 970-33
	Brushed Bronze	28 679 970-42
	Brushed Champagne (22kt Gold)	28 679 970-46
	Champagne (22kt Gold)	28 679 970-47
	Brushed Chrome	28 679 970-93
	Brushed Dark Platinum	28 679 970-99

**Recommended miscellaneous**



- Concealed wall elbow -** 35 085 970 90
- max. recess depth 163 mm
  - min. recess depth 90 mm

28 679 970

mm [inches]



Flow rate chart



Codes & Standards

DIN 4109

EN 1112

ISO 3822

Scottish Water  
Byelaws

UK Water Supply  
Regulations

Ü-Zeichen



## Rain shower with wall fixing 300 mm - Platinum

TARA

28 679 970

### Certificates

LGA\_29

DVGW\_DW-  
6517DN0

WRAS\_2212

28 679 970

Product version from 3/13/2017

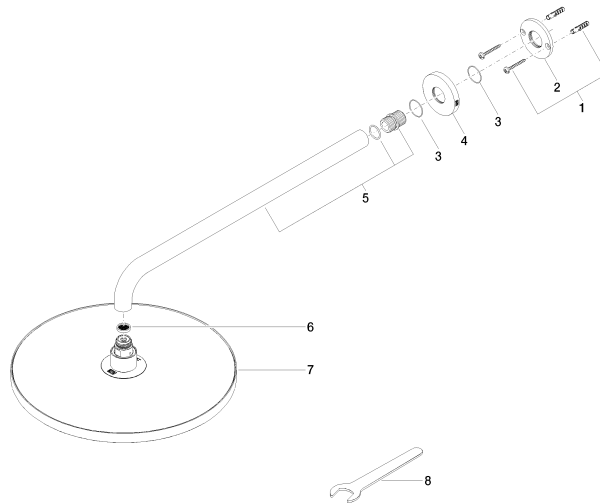



Rain shower with wall fixing 300 mm - Platinum

TARA

28 679 970

**Spare parts list**

**Product version from 3/13/2017**

No.	Item Number	Name	Quantity used	Delivery time
	04 30 31 032 00 90	fixing set	9	2