





33 805 875 Product version from 5/3/2021



- 166mm projection
- gauge mm
- pivotable spout 360°
- laminar flow
- height of mixer 303 mm
- height up to laminar flow regulator 186 mm
- hole diameter 35 mm
- max. flow 8 l/min at 3 bar flow pressure
- lead-free
- This product can help a building meet the requirements of Green Building Rating Systems, e.g. LEED®, BREEAM®, DGNB

	Brushed Chrome	33 805 875-93
	Chrome	33 805 875-00
	Brushed Platinum	33 805 875-06
	Platinum	33 805 875-08
	Durabronze (23kt Gold)	33 805 875-09
	Dark Chrome	33 805 875-19
	Brushed Durabronze (23kt Gold)	33 805 875-28
	Matte Black	33 805 875-33
	Brushed Champagne (22kt Gold)	33 805 875-46
	Champagne (22kt Gold)	33 805 875-47
	Brushed Dark Platinum	33 805 875-99

Recommended miscellaneous

Dispenser without rosette - Brushed Chrome 82 424 970-93



Recommended miscellaneous

Strainer waste with control handle - Brushed Chrome 10 712 970-93



33 805 875 Product version from 5/3/2021

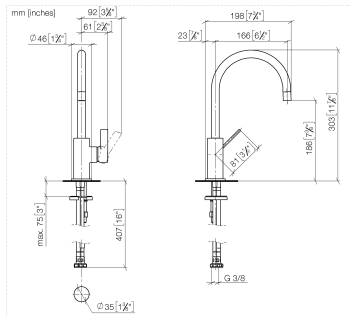

Flow rate chart

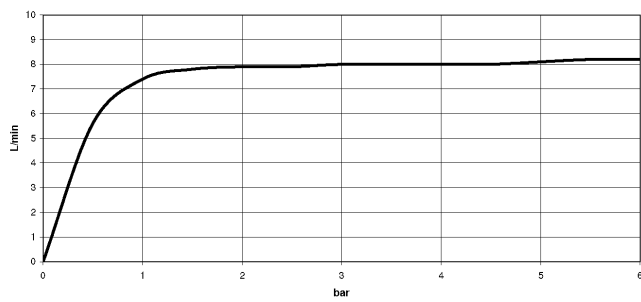

Codes & Standards

DIN 4109

ISO 3822

Ü-Zeichen



TARA ULTRA BAR TAP Single-lever mixer - Brushed Chrome

TARA ULTRA

33 805 875 Product version from 5/3/2021

Certificates

LGA_18

33 805 875 Product version from 5/3/2021

Parts for other finishes can be found here: [Chrome](#)

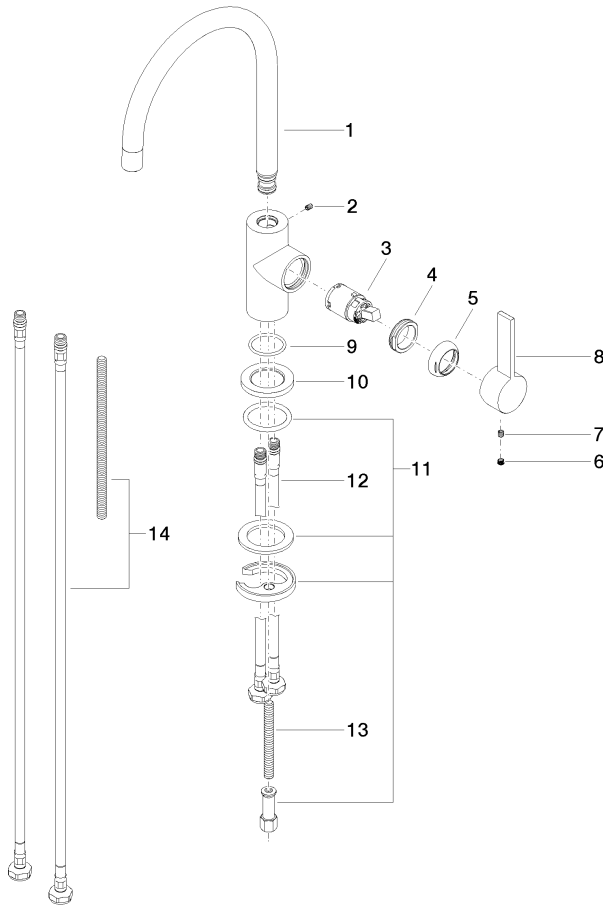

Spare parts list

No.	Item Number	Name	Quantity used	Delivery time
1	90 28 22 206 00-93	spout	1	20
2	09 31 11 008 90	pin	1	2
3	90 15 05 041 00 90	cartridge	1	2
4	09 24 04 130-07	nut	1	30
5	09 24 04 204-93	cover	1	60
6	90 31 20 109 00 90	plug	1	2
7	90 31 11 030 00 90	pin	1	2
8	09 20 88 051-93	handle	1	60
9	09 14 10 118 90	seal	1	2
10	09 27 85 001-93	rosette	1	60
11	04 30 11 038 64 90	fixing set	1	2
12	04 30 04 104 00 90	hose	2	2
13	09 31 11 011 90	pin	1	2
14	12 803 970 90	extension	1	60