

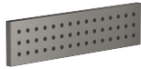













WATER BAR Concealed body spray - Brushed Dark Platinum

36 527 979 Product version from 10/1/2023



- HORIZONTAL RAIN, max. flow rate 9 l/min (at 3 bar)
- with anti-scale system
- cover plate 240 x 60 mm
- 1/2" connection

	Brushed Dark Platinum	36 527 979-99
	Chrome	36 527 979-00
	Brushed Platinum	36 527 979-06
	Platinum	36 527 979-08
	Dark Chrome	36 527 979-19
	Light Gold	36 527 979-26
	Brushed Light Gold	36 527 979-27
	Brushed Durabronze (23kt Gold)	36 527 979-28
	Matte Black	36 527 979-33
	Brushed Bronze	36 527 979-42
	Brushed Champagne (22kt Gold)	36 527 979-46
	Champagne (22kt Gold)	36 527 979-47
	Brushed Chrome	36 527 979-93

Required miscellaneous



- Concealed wall installation box -** 35 206 970 90
- min. recess depth mm
 - max. recess depth mm

Recommended miscellaneous



- xGRID Attachment set for integrating in the dry wall construction -** 12 340 970 90

Required miscellaneous



- xGRID Installation track 555 mm -** 12 360 970 90

WATER BAR Concealed body spray - Brushed Dark Platinum

36 527 979 Product version from 10/1/2023

mm [inches]

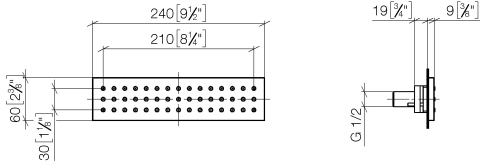

Flow rate chart

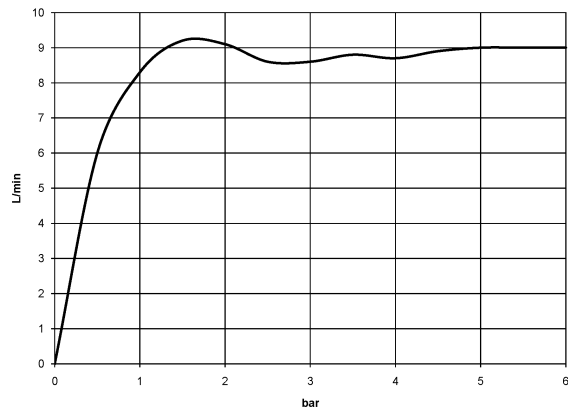

Codes & Standards

DIN 4109

ISO 3822

Ü-Zeichen



WATER BAR Concealed body spray - Brushed Dark Platinum

36 527 979 Product version from 10/1/2023

Certificates

LGA_38

WATER BAR Concealed body spray - Brushed Dark Platinum

36 527 979 Product version from 10/1/2023

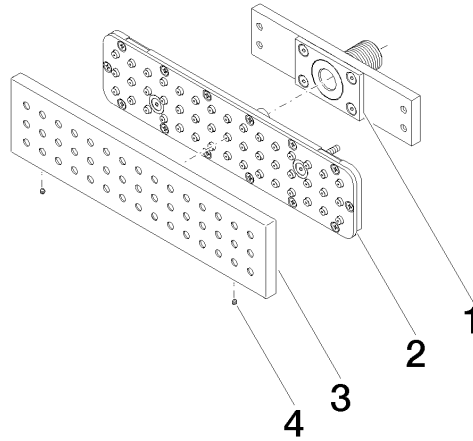

Spare parts list

No.	Item Number	Name	Quantity used	Delivery time
1	90 11 02 137 00 90	connection	1	2
2	90 11 02 332 01-00	insert	1	10
3	09 27 99 001-99	rosette	1	20
4	09 31 11 006 90	pin	2	2