



EDITION PRO Dispenser wall model - Chrome

83 435 626



- bottle made of crystal glass, matt
- width 60mm
- height 203 mm
- 250 ml bottle
- 100mm projection

	Chrome	83 435 626-00
	Matte Black	83 435 626-33
	Brushed Chrome	83 435 626-93

EDITION PRO Dispenser wall model - Chrome

83 435 626

mm [inches]

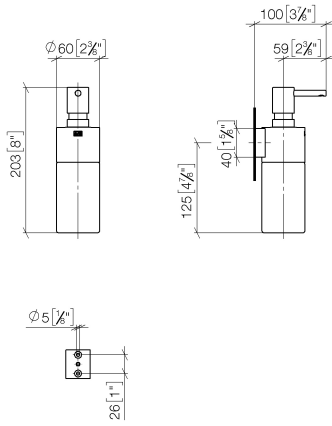

EDITION PRO Dispenser wall model - Chrome

83 435 626

Parts for other finishes can be found here: [Matte Black](#)

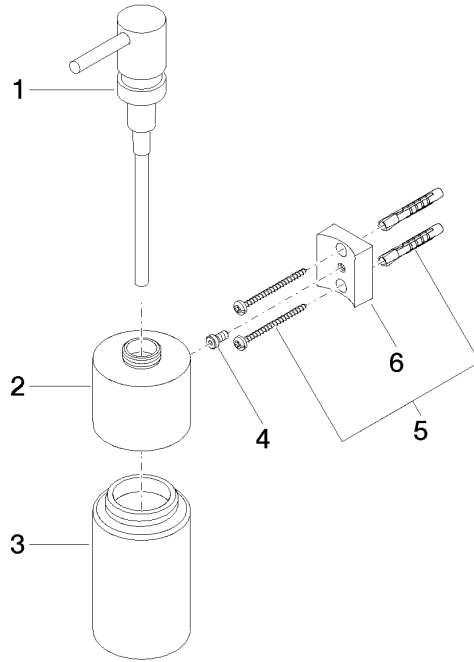

Spare parts list

No.	Item Number	Name	Quantity used	Delivery time
1	90 10 10 535 00-00	dispenser	1	30
2	90 10 10 525 00-00	base	1	10
3	90 90 04 001 00 82	glass	1	2
4	09 30 30 093 90	screw	1	2
5	05 30 31 025 00 90	fixing set	1	2
6	08 10 10 530-00	holder	1	10