





## EDITION PRO Tissue holder with cover - Brushed Chrome

---

83 510 626



- width 150mm
- height 95 mm
- rosette Ø 40 mm
- 40mm projection

	Brushed Chrome	83 510 626-93
	Chrome	83 510 626-00
	Matte Black	83 510 626-33



# EDITION PRO Tissue holder with cover - Brushed Chrome

83 510 626

mm [inches]

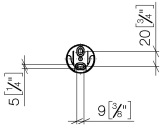
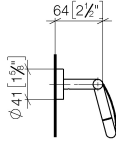
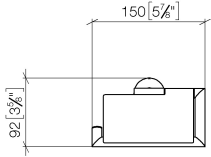

## EDITION PRO Tissue holder with cover - Brushed Chrome

---

83 510 626

Parts for other  
finishes can be found  
here: [Chrome](#)

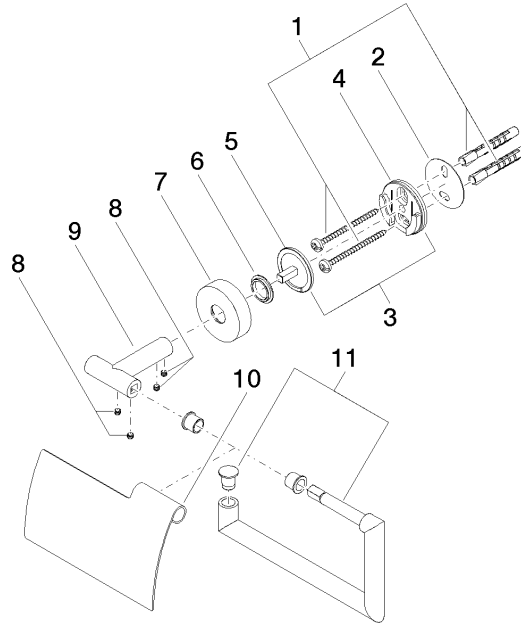



## EDITION PRO Tissue holder with cover - Brushed Chrome

---

83 510 626

### Spare parts list

No.	Item Number	Name	Quantity used	Delivery time
	05 30 31 025 00 90	fixing set	14	2