















Hand shower set with individual rosettes FlowReduce - Dark Chrome

27 808 980



- COMPACT RAIN, max. flow rate 6.8 l/min (at 3 bar)
- with anti-scale system
- 3/8" shower outlet
- rosette for wall elbow 60 x 60mm
- rosette for shower holder 60 x 60mm
- metal shower hose 1250mm with integrated anti-twist protection
- 1/2" wall elbow
- This product can help a building meet the requirements of Green Building Rating Systems, e.g. LEED®, BREEAM®, DGNB

Intrinsic protection against back flow.

	Dark Chrome	27 808 980-19 0010
	Chrome	27 808 980-00
	Chrome	27 808 980-00 0010
	Brushed Platinum	27 808 980-06
	Brushed Platinum	27 808 980-06 0010
	Platinum	27 808 980-08
	Platinum	27 808 980-08 0010
	Dark Chrome	27 808 980-19
	Brushed Light Gold	27 808 980-27 0010
	Brushed Light Gold	27 808 980-27
	Brushed Durabronze (23kt Gold)	27 808 980-28 0010
	Brushed Durabronze (23kt Gold)	27 808 980-28
	Matte Black	27 808 980-33
	Matte Black	27 808 980-33 0010
	Brushed Champagne (22kt Gold)	27 808 980-46 0010
	Champagne (22kt Gold)	27 808 980-47 0010
	Brushed Chrome	27 808 980-93
	Brushed Chrome	27 808 980-93 0010
	Brushed Dark Platinum	27 808 980-99
	Brushed Dark Platinum	27 808 980-99 0010

Recommended miscellaneous



- Concealed wall elbow -**
- max. recess depth mm
 - min. recess depth mm

35 085 970 90

Hand shower set with individual rosettes FlowReduce - Dark Chrome

27 808 980

mm [inches]

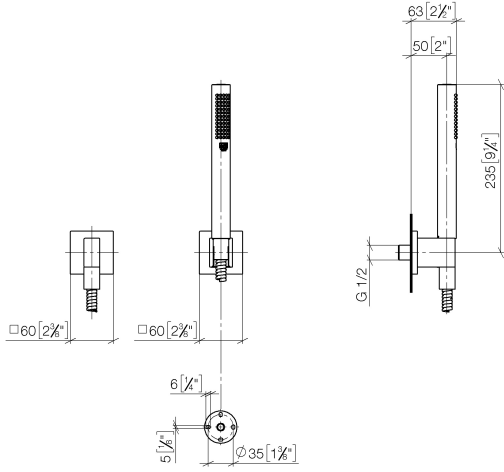

Flow rate chart

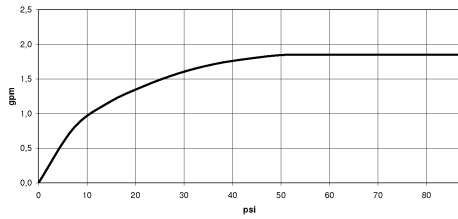

Codes & Standards

ASME A112.18.1

cUPC

DIN 4109

ISO 3822

Ü-Zeichen



Hand shower set with individual rosettes FlowReduce - Dark Chrome

27 808 980

Certificates

LGA_29

IAPMO_4976

Hand shower set with individual rosettes FlowReduce - Dark Chrome

27 808 980

