

MEM Single-lever mixer - Matte Black

MEM

33 800 682



- 201mm projection
- pivotable spout 360°
- Optional swivel limiter available with swivel limiter set 12 820 970 90
- air-enriched flow
- max. flow 6.3 l/min at 3 bar flow pressure
- lead-free
- This product can help a building meet the requirements of Green Building Rating Systems, e.g. LEED®, BREEAM®, DGNB
- WRAS 240202021

	Matte Black	33 800 682-33
	Chrome	33 800 682-00
	Brushed Platinum	33 800 682-06
	Platinum	33 800 682-08
	Durabronze (23kt Gold)	33 800 682-09
	Dark Chrome	33 800 682-19
	Brushed Durabronze (23kt Gold)	33 800 682-28
	Brushed Champagne (22kt Gold)	33 800 682-46
	Champagne (22kt Gold)	33 800 682-47
	Brushed Chrome	33 800 682-93
	Brushed Dark Platinum	33 800 682-99

Recommended miscellaneous

	Swivel limitation set -	12 820 970 90
---	--------------------------------	---------------

Recommended miscellaneous

	Dispenser without rosette - Matte Black	82 424 970-33
---	--	---------------

Recommended miscellaneous

	Strainer waste with control handle - Matte Black	10 712 970-33
---	---	---------------

33 800 682

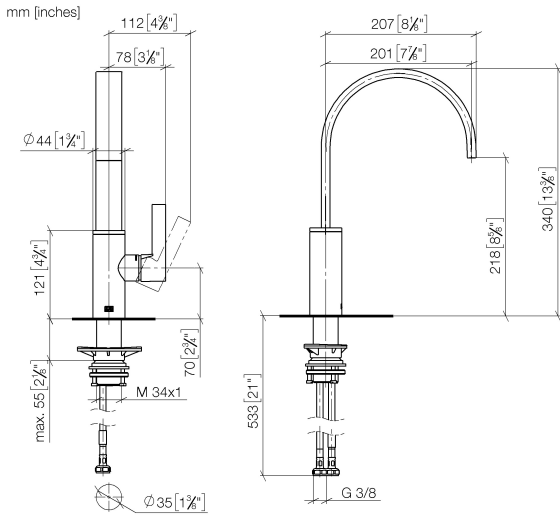

Flow rate chart

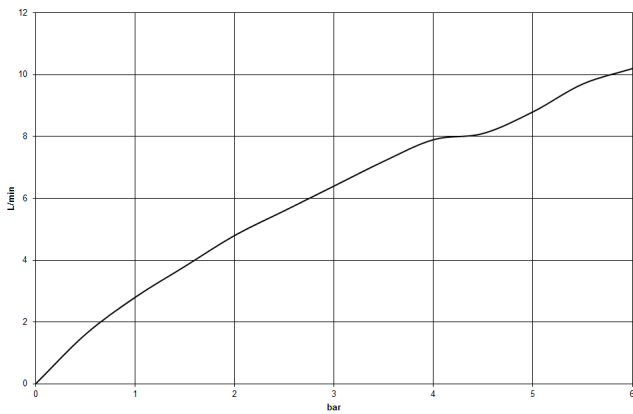

Codes & Standards

DIN 4109

ISO 3822

Scottish Water
Byelaws

UK Water Supply
Regulations

Ü-Zeichen



MEM Single-lever mixer - Matte Black

MEM

33 800 682

Certificates

WRAS_240202

LGA_38

33 800 682

Product version from 3/1/2023

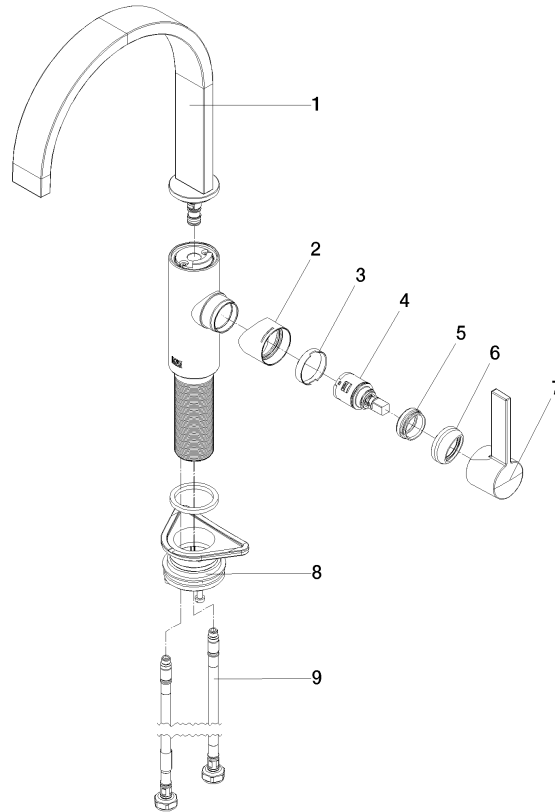



MEM Single-lever mixer - Matte Black

MEM

33 800 682

Spare parts list

Product version from 3/1/2023

No.	Item Number	Name	Quantity used	Delivery time
	90 28 22 332 00-33	spout	10	-

Spare part can no longer be ordered, please order the replacement item