

Wall valve clockwise closing 1/2" - Brushed Platinum













CL.1

36 607 740



- without rosette
- handle Ø 60mm
- without marking
- head part with cut-to-length spindle and sleeve
- WRAS 2011026, 2010066

Fits: CL.1, META, CYO

	Brushed Platinum	36 607 740-06
	Chrome	36 607 740-00
	Dark Chrome	36 607 740-19
	Light Gold	36 607 740-26
	Brushed Light Gold	36 607 740-27
	Brushed Durabronze (23kt Gold)	36 607 740-28
	Matte Black	36 607 740-33
	Brushed Bronze	36 607 740-42
	Brushed Champagne (22kt Gold)	36 607 740-46
	Champagne (22kt Gold)	36 607 740-47
	Brushed Chrome	36 607 740-93
	Brushed Dark Platinum	36 607 740-99

Required miscellaneous



- Wall valve 1/2" -** 35 607 970 90
- max. recess depth 145 mm
 - min. recess depth 85 mm

36 607 740

mm [inches]

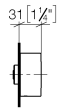
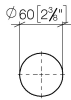

Codes & Standards

ASME A112.18.1	cUPC	DIN 4109	EN 1111
EN 200	ISO 3822	Scottish Water Byelaws	UK Water Supply Regulations

Ü-Zeichen

Certificates

IAPMO_4976	DVGW_DW-6501DN0	WRAS_2010	LGA_38	LGA_29
LGA_29	DVGW_DW-6512DN0	WRAS_2011		

36 607 740

Product version from 7/1/2023

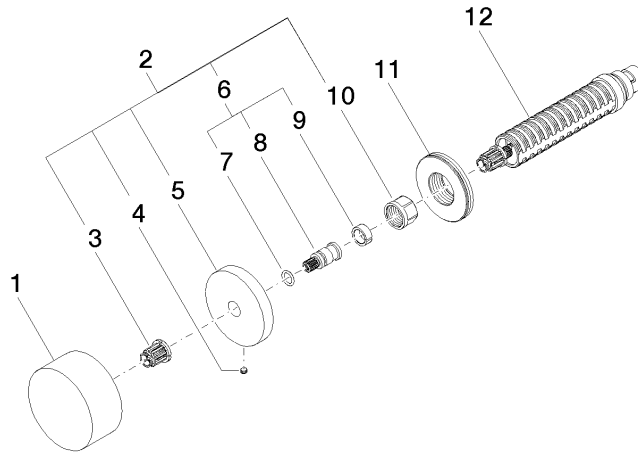



Wall valve clockwise closing 1/2" - Brushed Platinum

CL.1

36 607 740

Spare parts list

Product version from 7/1/2023

No.	Item Number	Name	Quantity used	Delivery time
	09 20 74 004-06	handle	12	60