

Decorative caps for Perfecto - Matte Black

IMO















12 801 970

• 1 pair

Including retaining screws available under order no.
12 800 970-FF



Fits: IMO, LULU, MADISON, MEM, TARA,
CL.1, LISSÉ, VAIA, META, CYO

	Matte Black	12 801 970-33
	Chrome	12 801 970-00
	Brushed Platinum	12 801 970-06
	Platinum	12 801 970-08
	Durabrand (23kt Gold)	12 801 970-09
	Dark Chrome	12 801 970-19
	Light Gold	12 801 970-26
	Brushed Light Gold	12 801 970-27
	Brushed Durabrand (23kt Gold)	12 801 970-28
		12 801 970-39
	Brushed Bronze	12 801 970-42
		12 801 970-43
	Brushed Champagne (22kt Gold)	12 801 970-46
	Champagne (22kt Gold)	12 801 970-47
	Brushed Chrome	12 801 970-93
	Brushed Dark Platinum	12 801 970-99

12 801 970

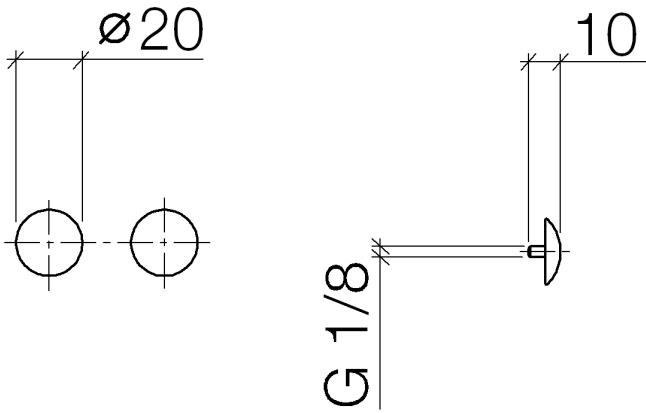



Decorative caps for Perfecto - Matte Black

IMO

12 801 970

Product version from 10/1/2023

Parts for other
finishes can be found
here: [Chrome](#)





Decorative caps for Perfecto - Matte Black

IMO

12 801 970

Spare parts list

Product version from 10/1/2023

No.	Item Number	Name	Quantity used	Delivery time
	09 30 30 060-33	screw	2	60