

WATER SHEET Cascade spout for wall mounting - Champagne (22kt Gold)













IMO

13 415 979



- 150mm projection
- CASCADE, max. flow rate 26.5 l/min (at 3 bar)
- cover plate 240 x 60 mm
- 1/2" connection
- plug-link mounting
- WRAS 2306001

Fits: IMO, LULU, MADISON, MEM, TARA, CL.1, LISSÉ, VAIA, META, CYO

	Champagne (22kt Gold)	13 415 979-47
	Chrome	13 415 979-00
	Brushed Platinum	13 415 979-06
	Platinum	13 415 979-08
	Dark Chrome	13 415 979-19
	Light Gold	13 415 979-26
	Brushed Light Gold	13 415 979-27
	Brushed Durabrass (23kt Gold)	13 415 979-28
	Matte Black	13 415 979-33
	Brushed Bronze	13 415 979-42
	Brushed Champagne (22kt Gold)	13 415 979-46
	Brushed Chrome	13 415 979-93
	Brushed Dark Platinum	13 415 979-99

Recommended miscellaneous

	Concealed wall elbow - •max. recess depth 163 mm •min. recess depth 90 mm	35 085 970 90
---	--	---------------

Recommended miscellaneous

	Concealed wall elbow - •max. recess depth 163 mm •min. recess depth 90 mm	35 085 970 90
---	--	---------------

13 415 979

mm [inches]

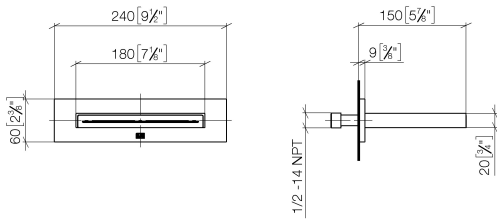

Flow rate chart

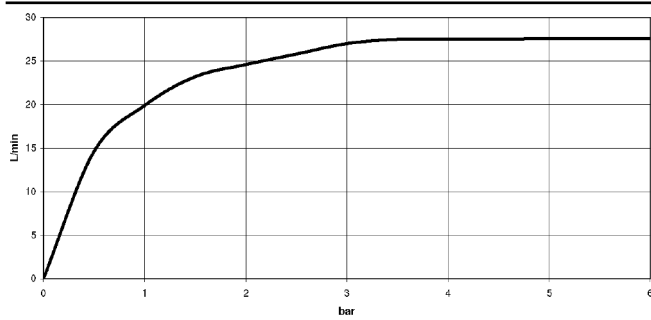

Trajectory diagram

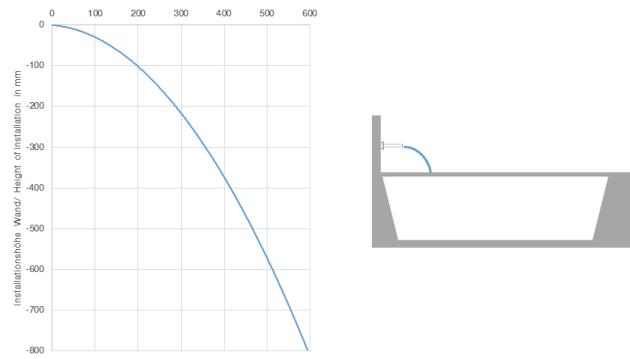

Certificates

WRAS_2306001.

13 415 979

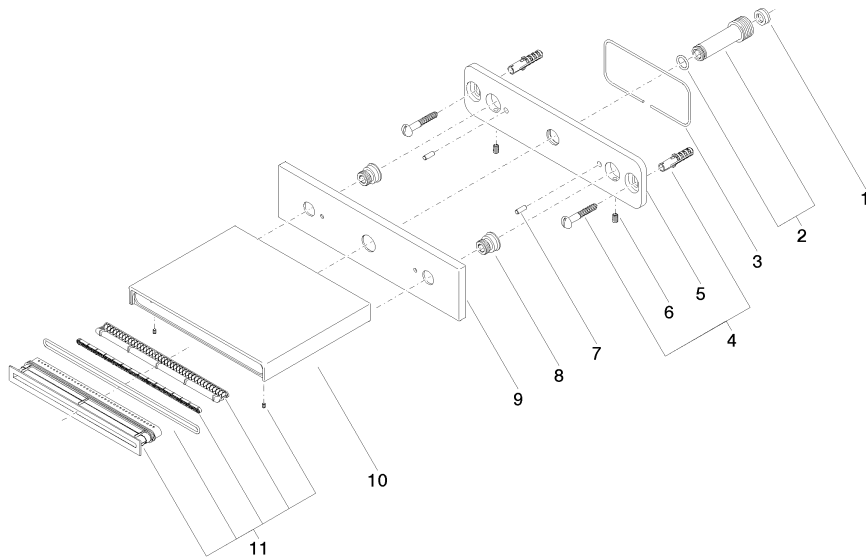

Spare parts list

No.	Item Number	Name	Quantity used	Delivery time
1	09 23 01 057 90	flow reducer	1	2
2	90 24 03 213 00 90	connection	1	2
3	09 14 03 134 90	seal	1	2
4	04 30 31 024 01 90	fixing set	1	2
5	09 17 97 059 90	holder	1	2
6	09 31 11 036 90	pin	2	2
7	09 31 11 040 90	pin	2	2
8	09 24 03 214 90	nipple	2	2
9	09 27 78 031-47	rosette	1	30
10	09 11 78 003 20-47	spout	1	30
11	90 29 03 059 00 90	insert	1	2