

27 718 809



- with round rosette
- spray flow
- automatic spout/shower diverter
- height of mixer 171 mm
- hole diameter rinsing spray 32mm
- fabric braided hose 1500 mm
- sprayface with anti-scaling system
- lead-free
- This product can help a building meet the requirements of Green Building Rating Systems, e.g. LEED®, BREEAM®, DGNB

Can only be combined with 33810809, 33826809, 19815809, 19825809.

Intrinsic protection against back flow.

Residual water may emerge from the spray after closing.

Operating unit can be positioned freely.

	Brushed Chrome	27 718 809-93
	Chrome	27 718 809-00
	Brushed Platinum	27 718 809-06
	Platinum	27 718 809-08
	Durabronze (23kt Gold)	27 718 809-09
	Dark Chrome	27 718 809-19
	Brushed Durabronze (23kt Gold)	27 718 809-28
	Matte Black	27 718 809-33
	Brushed Champagne (22kt Gold)	27 718 809-46
	Champagne (22kt Gold)	27 718 809-47
	Brushed Dark Platinum	27 718 809-99

27 718 809

mm [inches]

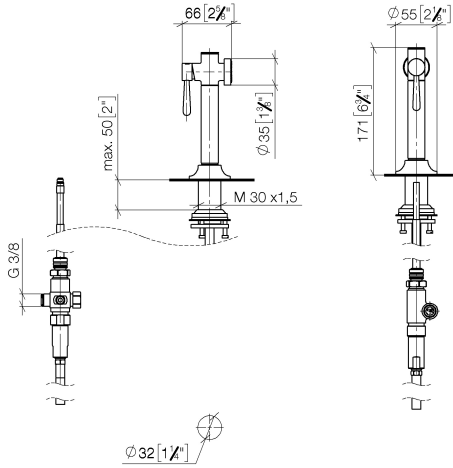

Flow rate chart



Codes & Standards

DIN 4109

ISO 3822

Ü-Zeichen



VAIA Rinsing spray set - Brushed Chrome

VAIA

27 718 809

Certificates

LGA_38

27 718 809

Product version from 7/1/2023

Parts for other finishes can be found here: [Chrome](#)

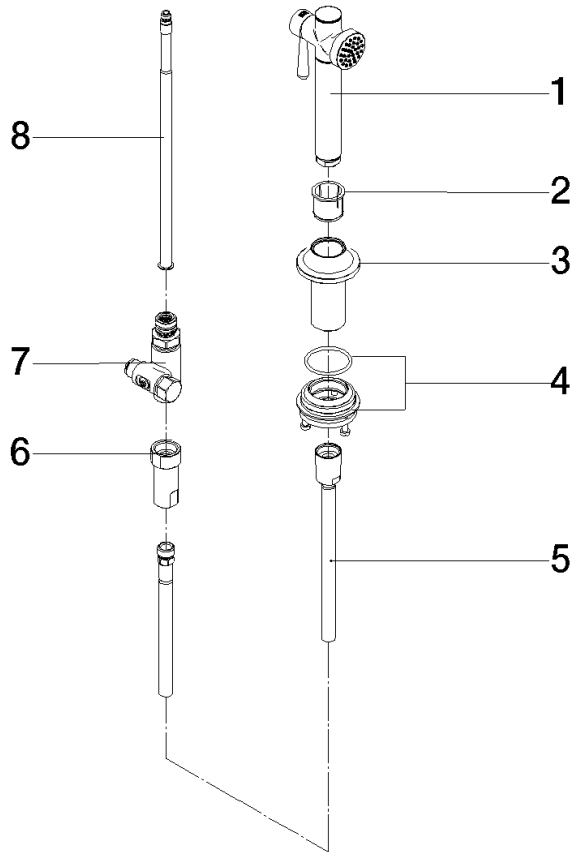



VAIA Rinsing spray set - Brushed Chrome

VAIA

27 718 809

Spare parts list

Product version from 7/1/2023

No.	Item Number	Name	Quantity used	Delivery time
	90 12 11 096 12-93	shower	8	60