

Hand shower - Brushed Bronze

IMO



























28 017 979



- COMPACT RAIN, max. flow rate 15 l/min (at 3 bar)
- with anti-scale system
- spray head Ø 130 mm
- 1/2" connection
- WRAS 2009011

Intrinsic protection against back flow.

Fits: IMO, LULU, MADISON, MEM, TARA,
CL.1, LISSÉ, VAIA, META, CYO

	Brushed Bronze	28 017 979-42
	Chrome	28 017 979-00
	Chrome	28 017 979-00 0010
	Brushed Platinum	28 017 979-06
	Brushed Platinum	28 017 979-06 0010
	Platinum	28 017 979-08
	Platinum	28 017 979-08 0010
	Dark Chrome	28 017 979-19
	Dark Chrome	28 017 979-19 0010
	Light Gold	28 017 979-26 0010
	Light Gold	28 017 979-26
	Brushed Light Gold	28 017 979-27 0010
	Brushed Light Gold	28 017 979-27
	Brushed Durabronze (23kt Gold)	28 017 979-28
	Brushed Durabronze (23kt Gold)	28 017 979-28 0010
	Matte Black	28 017 979-33 0010
	Matte Black	28 017 979-33
	Brushed Bronze	28 017 979-42 0010
	Brushed Champagne (22kt Gold)	28 017 979-46
	Brushed Champagne (22kt Gold)	28 017 979-46 0010
	Champagne (22kt Gold)	28 017 979-47
	Champagne (22kt Gold)	28 017 979-47 0010
	Brushed Chrome	28 017 979-93
	Brushed Chrome	28 017 979-93 0010
	Brushed Dark Platinum	28 017 979-99 0010
	Brushed Dark Platinum	28 017 979-99



Hand shower - Brushed Bronze

IMO

28 017 979

28 017 979

mm [inches]

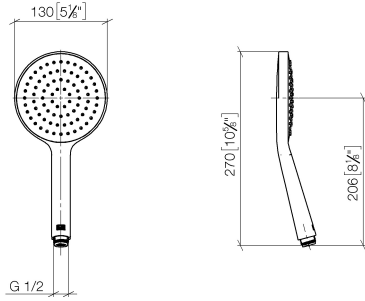

Flow rate chart



Codes & Standards

DIN 4109

ISO 3822

Ü-Zeichen



Hand shower - Brushed Bronze

IMO

28 017 979

Certificates

LGA_29

28 017 979

Product version from 4/1/2024

Parts for other
finishes can be found
here: [Chrome](#)

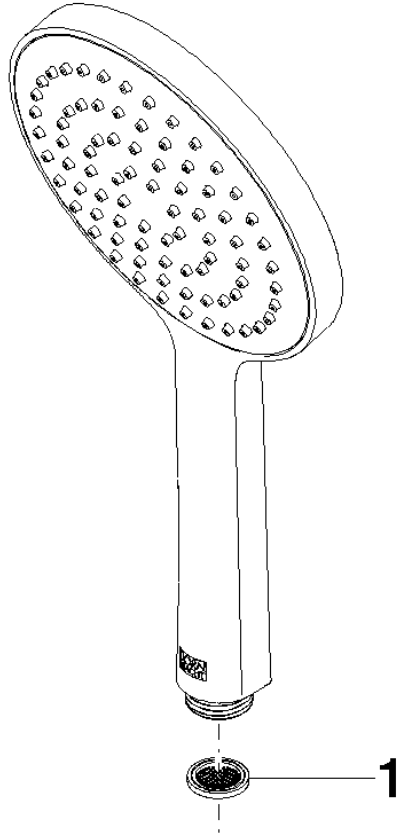



Hand shower - Brushed Bronze

IMO

28 017 979

Spare parts list

Product version from 4/1/2024

No.	Item Number	Name	Quantity used	Delivery time
	09 23 01 039 90	sieve	1	2