











**META Wall-mounted valve cold water without pop-up waste - Brushed
Champagne (22kt Gold)**

META

30 010 662



- 126mm projection
- fixed spout
- circular, air-enriched flow
- hole diameter 35 mm
- rosette Ø 60 mm
- max. flow 5.7 l/min
- lead-free
- This product can help a building meet the requirements of Green Building Rating Systems, e.g. LEED®, BREEAM®, DGNB

	Brushed Champagne (22kt Gold)	30 010 662-46
	Chrome	30 010 662-00
	Brushed Platinum	30 010 662-06
	Dark Chrome	30 010 662-19
	Light Gold	30 010 662-26
	Brushed Light Gold	30 010 662-27
	Matte Black	30 010 662-33
	Brushed Bronze	30 010 662-42
	Champagne (22kt Gold)	30 010 662-47
	Brushed Chrome	30 010 662-93
	Brushed Dark Platinum	30 010 662-99

**META Wall-mounted valve cold water without pop-up waste - Brushed
Champagne (22kt Gold)**

META

30 010 662
mm [inches]

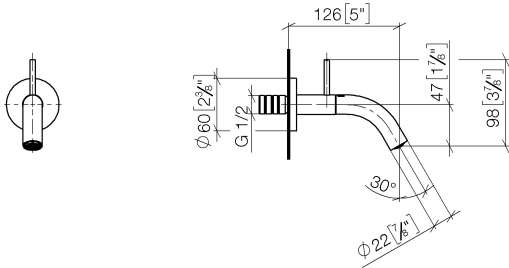

Flow rate chart



Codes & Standards

DIN 4109

ISO 3822

Ü-Zeichen



**META Wall-mounted valve cold water without pop-up waste - Brushed
Champagne (22kt Gold)**

META

30 010 662

Certificates

LGA_38

30 010 662

Product version from 5/1/2022

Parts for other
finishes can be found
here: [Chrome](#)

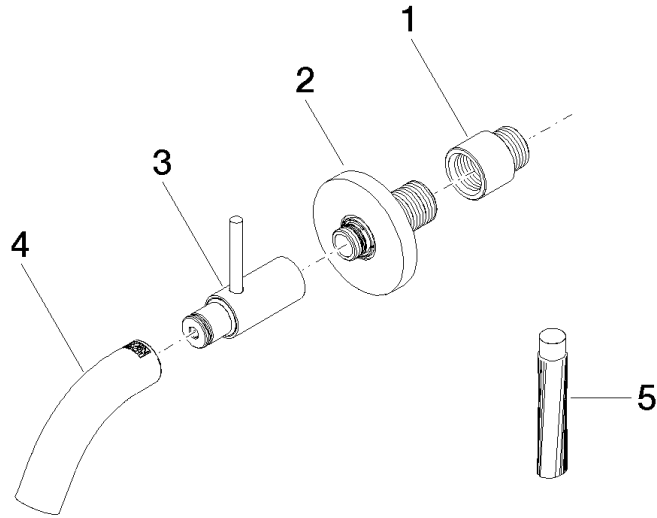



**META Wall-mounted valve cold water without pop-up waste - Brushed
Champagne (22kt Gold)**

META

30 010 662

Spare parts list

Product version from 5/1/2022

No.	Item Number	Name	Quantity used	Delivery time
	09 24 03 072 10 90	nipple	5	2