









LOT Two-hole mixer with individual rosettes - Brushed Durabron (23kt Gold)

LOT

32 800 680



- 235mm projection
 - pivotable spout 360°
 - air-enriched flow
 - height of mixer 345 mm
 - height up to aerator 319 mm
 - individual rosette 55 x 55 mm
 - hole diameter spout 35 mm
 - single-lever mixer hole diameter 44 mm
 - max. flow 8 l/min at 3 bar flow pressure
 - lead-free
 - WRAS 1909073
 - This product can help a building meet the requirements of Green Building Rating Systems, e.g. LEED®, BREEAM®, DGNB
- Operating unit can be positioned freely.

	Brushed Durabron (23kt Gold)	32 800 680-28
	Chrome	32 800 680-00
	Brushed Platinum	32 800 680-06
	Platinum	32 800 680-08
	Dark Chrome	32 800 680-19
	Brushed Champagne (22kt Gold)	32 800 680-46
	Champagne (22kt Gold)	32 800 680-47
	Brushed Dark Platinum	32 800 680-99

Recommended miscellaneous

Strainer waste with control handle - Brushed Durabron (23kt Gold) 10 711 970-28



Recommended miscellaneous

Dispenser with rosette - Brushed Durabron (23kt Gold) 82 439 970-28



32 800 680

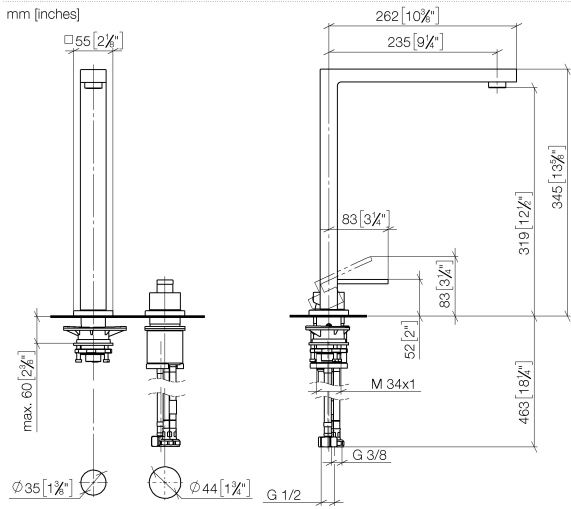

Flow rate chart



Codes & Standards

DIN 4109	EN 817	Executive Order no. 1007	ISO 3822
Scottish Water Byelaws	UK Water Supply Regulations	Ü-Zeichen	VA-Zeichen



LOT Two-hole mixer with individual rosettes - Brushed Durabronz (23kt Gold)

LOT

32 800 680

Certificates

LGA_18

WRAS_1909

GDV_0400

LGA_18

ETA_18

32 800 680

Product version from 5/31/2010 to 3/10/2021

Product version from 3/10/2021 to 5/10/2021

Product version from 5/10/2021

Product version from 6/1/2022

Parts for other finishes can be found here: [Chrome](#)

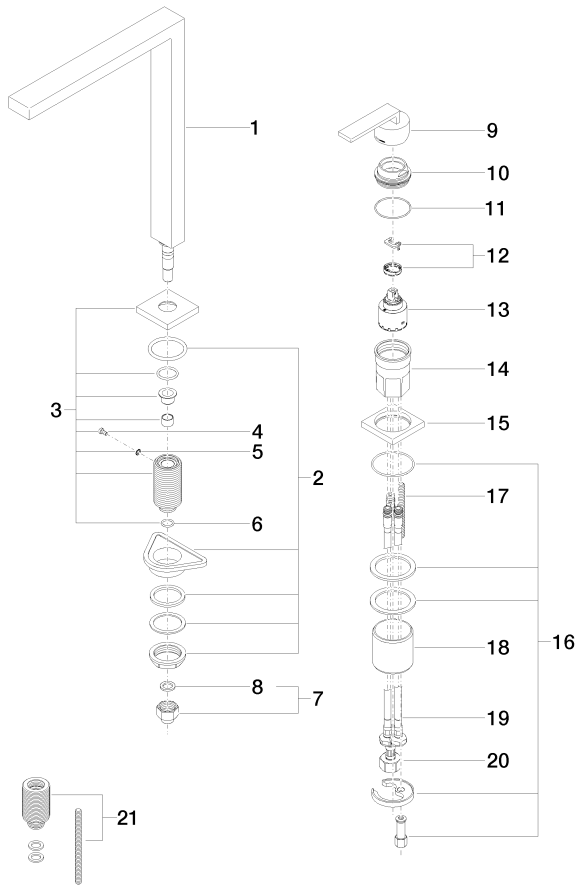



LOT Two-hole mixer with individual rosettes - Brushed Durabronz (23kt Gold)

LOT

32 800 680

Spare parts list

Product version from 5/31/2010 to 3/10/2021

Product version from 3/10/2021 to 5/10/2021

Product version from 5/10/2021

Product version from 6/1/2022

No.	Item Number	Name	Quantity used	Delivery time
	90 11 06 188 06-28	spout	22	20